

CARDIO
CARDIO

Steelflex

TREADMILL

USER MANUAL V.7

TABLE OF CONTENTS

GROUNDING INSTRUCTIONS.....	2
SAFETY INSTRUCTIONS.....	3
INSTALLATION.....	6
TREADMILL OVERVIEW.....	8
OPERATING INSTRUCTIONS FOR CTI.....	9
OPERATING INSTRUCTIONS FOR PT7/PT10.....	22
OPERATING INSTRUCTIONS FOR XT8000A / XT8000D.....	42
MAINTENANCE.....	57
WARRANTY.....	58

GROUNDING INSTRUCTIONS

This product must be grounded. If it should malfunction or breakdown, grounding provides a path of least resistance for electric current to reduce the risk of electric shock. This product is equipped with a cord having an equipment-grounding conductor and grounding plug. The plug must be plugged into an appropriate outlet that is properly installed and grounded in accordance with all local codes and ordinances.

DANGER-Improper connection of the equipment-grounding conductor can result in a risk of electric shock. Check with a qualified electrician or serviceman if you are in doubt as to whether the product is properly grounded. Do not modify the plug provided with the product- if it will not fit the outlet, have a proper outlet installed by a qualified electrician.

Make sure that the product is connected to an outlet having the same configuration as the plug. No adapter should be used with this product.

- The appliance must be positioned so that the plug is accessible.
- If the power cord is damaged, it must be replaced by the manufacturer or its service agent or a similarly qualified person in order to avoid a safety hazard.

SAFETY INSTRUCTIONS

IMPORTANT SAFETY INSTRUCTIONS

When using an electrical appliance, basic precautions should always be followed, including the following:

Read all instructions before using the Treadmill.

DANGER - To reduce the risk of electric shock:

Always unplug this appliance from the electrical outlet immediately after using and before cleaning.

WARNING - To reduce the risk of burns, fire, electric shock, or injury to persons:

1. An appliance should never be left unattended when plugged in. Unplug from outlet when not in use, and before putting on or taking off parts.
2. Close supervision is necessary when this appliance is used by, on, or near children, invalids, or disabled persons.
3. Use this appliance only for its intended use as described in this manual. Do not use attachments not recommended by the manufacture.
4. Never operate this appliance if it has a damaged cord or plug, if it is not working properly, if it has been dropped or damaged, or dropped into water. Call service for examination and repair.
5. Keep the cord away from heated surfaces.
6. Never drop or insert any object into any opening.
7. Do not use outdoors.

8. To disconnect, turn all controls to the off position, then remove plug from outlet.
9. Connect this appliance to a properly grounded outlet only.
See Grounding Instructions.
10. Never Tie off Safety Cord, as this will bypass the SAFE use, could cause a choking hazard for children, and / or present other unsafe use of product. Remove and store safety cord and plug after use. Keep out of reach of children.
11. The appliance is not to be used by children or persons with reduced physical, sensory or mental capabilities, or lack of experience and knowledge, unless they have been given supervision or instruction.
12. Children being supervised not to play with the appliance.
13. WARNING:
REMOVE CONTROL BOX (OR KEY, OR SAFETY PIN) WHEN NOT IN USE AND STORE OUT OF REACH OF CHILDREN.
AVERTISSEMENT:
RETIRER LA CLÉ DE SÉCURITÉ QUAND L'APPAREIL N'EST PAS EN SERVICE, ET LA PLACER HORS D'ATTEINTE DES ENFANTS.
14. CAUTION:
RISK OF INJURY TO PERSONS – TO AVOID INJURY, USE EXTREME CAUTION WHEN STEPPING ONTO OR OFF OF A MOVING BELT.
READ INSTRUCTION MANUAL BEFORE USING.
15. For commercial use.

PRUDENCE:

RISQUE DE BLESSURES - POUR ÉVITER LES BLESSURES, FAIRE PREUVE DE PRUDENCE EXTRÊME LORSQUE L'INTENSIFICATION DANS OU HORS D'UN TAPIS ROULANT. LIRE LES INSTRUCTIONS MANUEL AVANT D'UTILISER

15.CAUTION:

To Reduce The Risk Of Injury From Moving Parts - Unplug Before Servicing.

ATTENTION: Pour réduire les risques de blessures des pièces en mouvement - Débranchez avant tout entretien.

16.WARNING:

To Reduce the Risk of Electric Shock – Unplug Before Cleaning or Servicing.

AVERTISSEMENT - Pour réduire le risque de choc électrique - le débrancher avant de nettoyer ou de réparer.

SAVE THESE INSTRUCTIONS

Figure Grounding methods

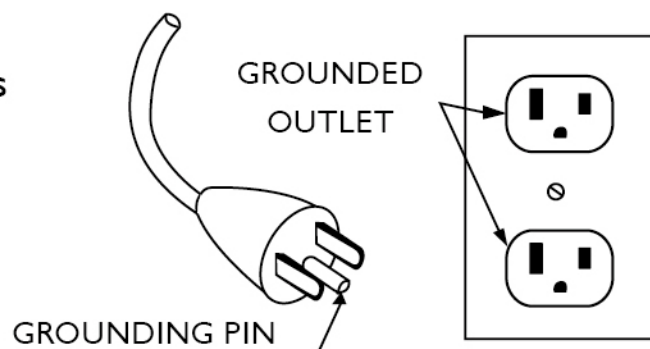

Note: Illustration is for Example purposes only. Your Treadmill plug and required outlet may look different. DO NOT MODIFY plug that comes with treadmill.

INSTALLATION

ELECTRICAL REQUIREMENT

Your **STEELFLEX** treadmill is intended for use in the country to which it was shipped. Electrical supplies outside of this country may differ and may not be compatible with the product. Please consult Customer Support before using the treadmill in a different country.

LOCATION

When choosing a location for the treadmill, pick a location that is unobstructed. The treadmill must have the following clearance.

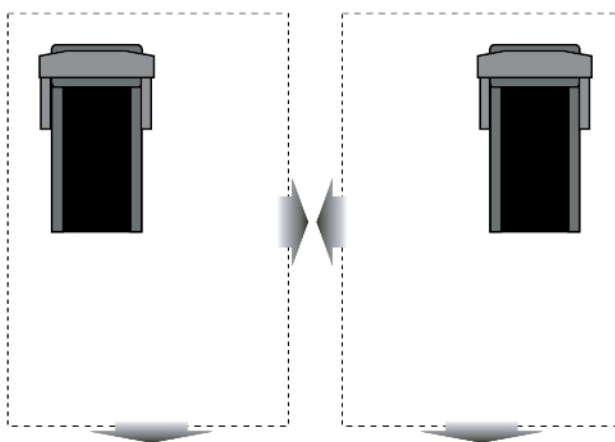

- Non-entry side of treadmill - Minimum of 8 inches (20cm)
- Entry side of treadmill - Minimum of 36 inches (90cm)
- Front of the treadmill - Minimum of 12 inches (30cm)
- Behind treadmill - Minimum of 6 feet (180cm)

These spacing requirements are mandatory for the safe use of the treadmill. If an accident occur, you must have sufficient space to move away from the treadmill.

GROUNDING INSTRUCTIONS

The treadmill must be properly grounded prior to use. Proper grounding reduces the risk of shock or damage to the treadmill. The power cord's plug is equipped with a grounding conductor that must be used with an electrical outlet installed in accordance to all local codes and ordinances. **DO NOT** use a temporary adapter that bypasses this function. This will stop the safety equipment from functioning properly and may void your warranty.

DO NOT MODIFY the plug provided with this product. If it will not fit an electrical outlet, have a proper outlet installed by a qualified electrician.

LEVELER LEGS

After finding a location that is suitable for the treadmill, the rear legs must be adjusted to provide stable support. Located on the side of each leg is a thumb-wheel that will allow you to lower or raise the leg until it is properly seated on the floor.

DO NOT adjust legs while the treadmill is on. Turn the power switch to the OFF position before adjustment.

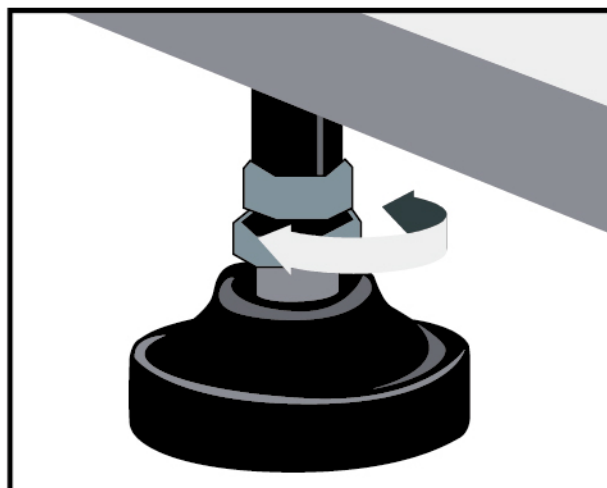

TREADMILL OVERVIEW

POWER SWITCH

The power switch is located on the side of the treadmill near the power cord. The power switch has two positions - ON and OFF.

The display console will beep when the treadmill is plugged in and the power switch is pressed ON.

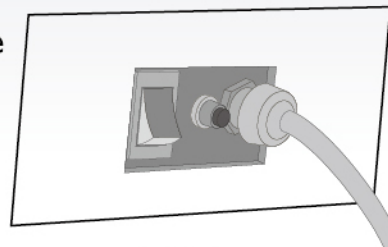

CIRCUIT BREAKER RESET

The circuit breaker is located next to the power switch. If there should be an electrical overload due to a surge in electricity or other situation, the circuit breaker will disconnect and attempt to prevent any damage from occurring to the treadmill.

If the treadmill suddenly stops with no lights visible nor beep heard, the circuit breaker may need to be reset. To reset the circuit breaker press the button firmly. The display console should restart and a beep should be heard.

CAUTION

Feel the power cord with your hands. If the power cord is warm to the touch a problem may exist with the electrical outlet in which the treadmill is plugged. It may be necessary to plug the treadmill into a different outlet.

POWER CORD

The power cord of the treadmill must be plugged into a properly grounded electrical outlet. Locate the power cord so it will not come in contact with the wheels of the treadmills during operation. This may cause the power cord to become pinched or damaged . Damage to the power cord could result in a fire hazard or cause personal injury through electrical shock.

OPERATING INSTRUCTIONS FOR CTI

Display instruction

The display of your CTI is used to operate the unit. It includes information windows, matrix window and button location.

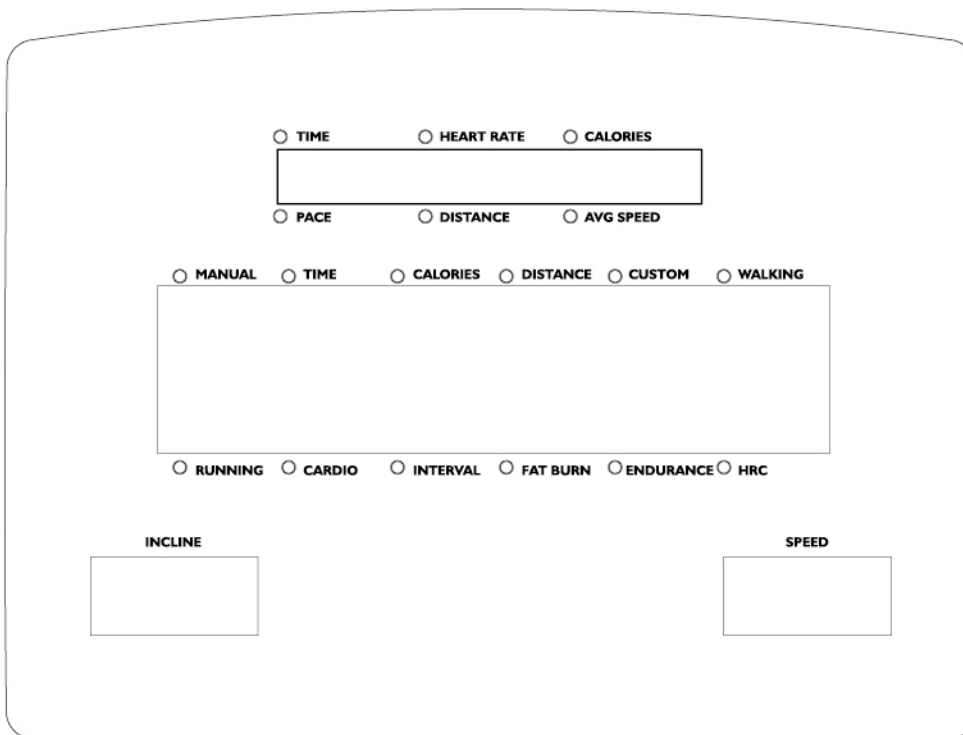

Information Window

Matrix Window

Information Window

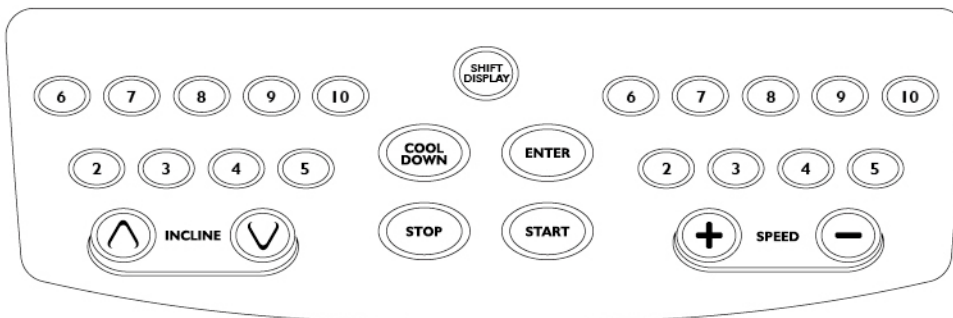

Button Location

INFORMATION WINDOW

The information windows provide two different types of information: program directions and user information data. Program directions will be explained with programs later. User information data includes:

User information Data	Description
TIME	Indicates time in minutes and seconds (mm:ss).
HEART RATE	Indicates heart rate beats per minute during your workout. (Only displayed if you are using contact heart rate bar or chest belt.)
CALORIES	Indicates accumulated calories burned during your workout.
PACE	Indicates time required per mile or kilometer.
DISTANCE	Indicates exercising distance of your workout.
AVG SPEED	Indicates average speed of your workout.
INCLINE	Indicates current incline of your workout.
SPEED	Indicates speed of your workout. (Either miles or kilometers.)





Matrix window

The Matrix Window displays the workout program you select. Each program displays a different exercise profile. Flashing lamp bar in the window displays your location on the exercise course.

Button Location

There are buttons for operating the machine, adjusting incline level, and adjusting exercise speed. A description of each button is listed below.

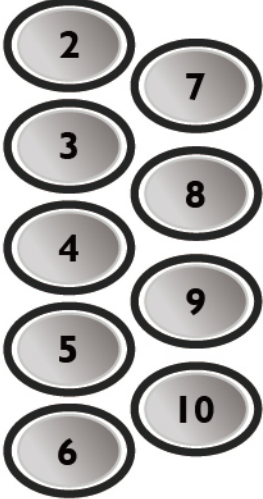
	Start your workout.
	Enter Data
	Stop your workout
	Stop your workout slowly
	Change (TIME \ HEART RATE \ CALORIES) and (PACE \ DISTANCE \ AVG SPEED) value.
	Adjust speed. Every press will increase 0.1 mile. Press and hold this button to increase quickly.







	Adjust speed. Every press will decrease 0.1 mile. Press and hold this button to decrease quickly.
	Adjust incline level. Every press will increase 1 level. Press and hold this button to increase quickly.
	Adjust incline level. Every press will decrease 1 level. Press and hold this button to decrease quickly.
	<p>Numeric key. User can adjust incline and speed by these quick keys.</p> <p>NOTE:</p> <p>When using Speed quick key to increase speed from the displayed speed, when user presses a quick key for a speed faster than indicated, the user must then press “” to verify speed selection before change will occur.</p>

Programs

There are different exercise programs, includes manual, set time, set calories, set distance, custom (1 and 2), walking, running, cardio, interval, fat burn, endurance and HRC. Operations are explained as follows.

Press “  ”, when asked in the scrolling display to enable elevation / incline.

Manual

<p>step 1</p>	<p>Turn on the power and press “  ” 、 “  ” 、 “  ” or “  ” to set your weight and press “  ”. The default value is 176 LBS.</p>
<p>step 2</p>	<p>Press “  ” .</p>

Center Display counts down 3 seconds, and then starts belt.













During your workout, you can change speed and incline using Quick Keys, corresponding arrow or “+” “-“ keys

When Using Speed Quick keys, for any Increase in speed, user

Must press “  ” after selection before Speed will Increase.

Press “  ”, when asked in the scrolling display to enable elevation / incline.

SET TIME / SET CALORIES / SET DISTANCE

<p>step 1</p>	<p>Turn on the power press “  ”、“  ”、“  ” or “  ” to set your weight and press “  ”. The default value is 176 LBS.</p>
<p>step 2</p>	<p>Press “  ” or “  ” to select TIME/CALORIES/DISTANCE program, then press “  ”.</p>
<p>step 3</p>	<p>Use “  ”、“  ”、“  ” or “  ” to set time/calories/distance then press “  ”.</p>

Center Display counts down 3 seconds, and then starts belt.





















During your workout, you can change speed and incline using Quick Keys, corresponding arrow or “+” “-“ keys.

When Using Speed Quick keys, for any Increase in speed, user

Must press “  ” after selection before Speed will Increase.

Press “  ”, when asked in the scrolling display to enable elevation / incline.

CUSTOM LEARN 1 / CUSTOM LEARN 2



















step 1	Turn on the power and press “  ” 、 “  ” 、 “  ” or “  ” to set your weight, then press “  ”. The default value is 176 LBS.
step 2	Press “  ” or “  ” to select CUSTOM program, then press “  ”.
step 3	To Program, press “  ” after changing profile segment, press “  ” and repeat. When complete press “  ”, display will show Time of workout.
step 4	Two custom programs can be memorized. Press “  ” or “  ” to set incline level. Press “  ” or “  ” to set speed.
step 5	Press “  ” 、 “  ” 、 “  ” or “  ” to set your exercise time, then press “  ”.

Center Display counts down 3 seconds, and then starts belt. During your workout, you can change speed and incline using Quick Keys, corresponding arrow or “+” “-” keys.

When Using Speed Quick keys, for any Increase in speed, user Must press “  ” after selection before Speed will Increase.

Press “  ”, when asked in the scrolling display to enable elevation / incline.

WALKING/RUNNING/CARDIO/INTERVAL/FAT BURN/ ENDURANCE



















step 1	Turn on the power. Press “  ” 、 “  ” 、 “  ” or “  ” to set your weight, then press “  ”. The default value is 176 LBS.
step 2	Press “  ” or “  ” to select WALKING/ RUNNING/ CARDIO/ INTERVAL /FAT BURN/ ENDURANCE program, then press “  ”.
step 3	Press “  ” 、 “  ” 、 “  ” or “  ” to choose from three different exercise levels, then press “  ”.
step 4	Press “  ” 、 “  ” 、 “  ” or “  ” to set exercise time, then press “  ”.

Center Display counts down 3 seconds, and then starts belt. During your workout, you can change speed and incline using Quick Keys, corresponding arrow or “+” “-“ keys. When Using Speed Quick keys, for any Increase in speed, user Must press “  ” after selection before Speed will Increase.

NOTE: These programs will NOT allow manual changing of Elevation during routine. Speed can be changed, but Speed profile will now show User change for the rest of the routine.

Press “  ”, when asked in the scrolling display to enable elevation / incline.

HEART RATE CONTROL

<p>step 1</p>	<p>Turn on the power. Press “  ” 、 “  ” 、 “  ” or “  ” to set your weight, then press “  ”. The default value is 176 LBS.</p>
<p>step 2</p>	<p>Press “  ” or “  ” to select HRC program, then press “  ”.</p>
<p>step 3</p>	<p>Press “  ” 、 “  ” 、 “  ” or “  ” to set age. The default value is 25. Then press “  ” .</p>
<p>step 4</p>	<p>Press “  ” 、 “  ” 、 “  ” or “  ” to set max heart rate %. The default value is 60%, then press “  ” . Press “  ” to begin.</p>

Center Display counts down 3 seconds, and then starts belt. During your workout, you can change speed and incline using Quick Keys, corresponding arrow or “+” “-“ keys. When Using Speed Quick keys, for any Increase in speed, user Must press “  ” after selection before Speed will Increase.

Press “  ”, when asked in the scrolling display to enable elevation / incline.









Heart rate checks are made every 15 seconds-

- A. If heart rate is less than 50 bpm, (regardless of target), elevation will move to 0%, after 0%, speed will reduce by 0.1 mph every 15 seconds, when minimum speed is reached, end exercise will occur.
- B. If heart rate is less than 3 bpm below target, there will be no change.
- C. If heart rate is between 3 and 5 bpm below target, elevation will increase by 0.5% every 30 seconds.
- D. If heart rate is between 6 and 10 bpm below target, elevation will increase by 1% every 30 seconds.
- E. If heart rate is between 11 and 20 bpm below target, elevation will increase by 1% every 15 seconds.
- F. If heart rate is more than 20 bpm below target, no change will occur, as system assumes that there may be an error in the heart rate signal. User must ensure that Chest Strap is working properly.
- G. If heart rate is less than 3 bpm Above target, there is no change.
- H. If heart rate is more than 3 bpm Above target, elevation will decrease by 1% every 15 seconds. When elevation reaches 0%, then speed will begin lowering 0.1 mph every 15 seconds, until minimum is reached or heart rate is on target range.

USER CAN AND SHOULD STOP HEART RATE CONTROL PROGRAM AT ANY TIME FOR ANY OVERWORK OR OUT OF RANGE CONDITION, JUST BY PRESSING ANY **STOP BUTTON**, OR REMOVING THE SAFETY KEY.

Press “”, when asked in the scrolling display to enable elevation / incline.

NOTE:

1. Press “  ” during exercise, speed will decrease to “0”, but elevation will not change. After treadmill belt has stopped, the information window for (TIME, HEART RATE, CALORIES, then PACE, DISTANCE, AVG SPEED) will rotate between values every 5 seconds, a large STOP will show in the dot matrix. This is telling you to press the “  ” to reset treadmill last user information. If the user presses “  ” before “  ”, routine will begin at minimum speed, and routine will “Add” to the exercise values displayed.
2. Pressing “  ” during a routine will begin slowly decreasing speed and elevation until minimums are reached, and then belt stops. After belt stops, user can restart by pressing “  ” or press “  ” to reset.
3. Press “  ”, when asked in the scrolling display to enable elevation / incline.

CTI RUN BELT ADJUSTMENT

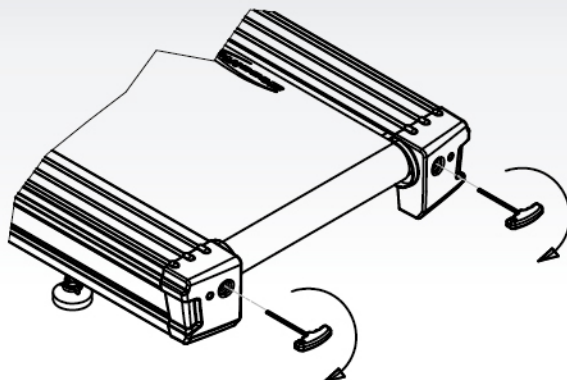

After assembly and before turning power on position the rear roller using the ' T ' wrench (refer to the drawing if needed) . make 3 turns clockwise to avoid the belt from slipping.

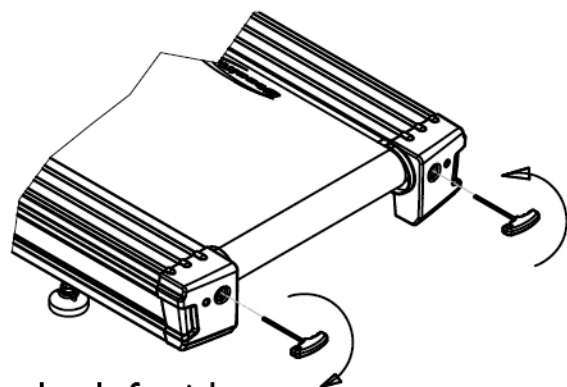

If belt is too far to the left side

- 1)turn the left roller bolt 1/4 turn clockwise(tighten)
- 2)turn the right roller 1/4 turn counterclockwise(loosen)

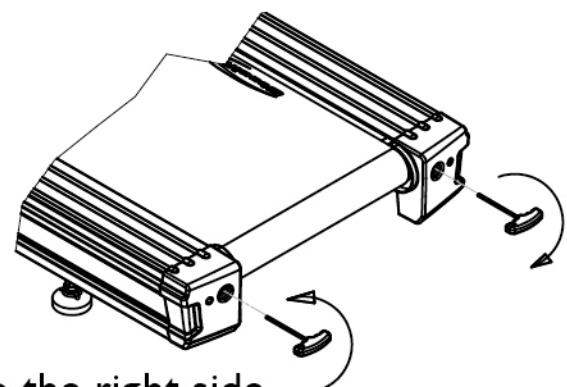

If belt is too far to the right side

- 1)turn the right roller bolt 1/4 turn clockwise(tighten)
- 2)turn the left roller bolt 1/4 turn counterclockwise(loosen)

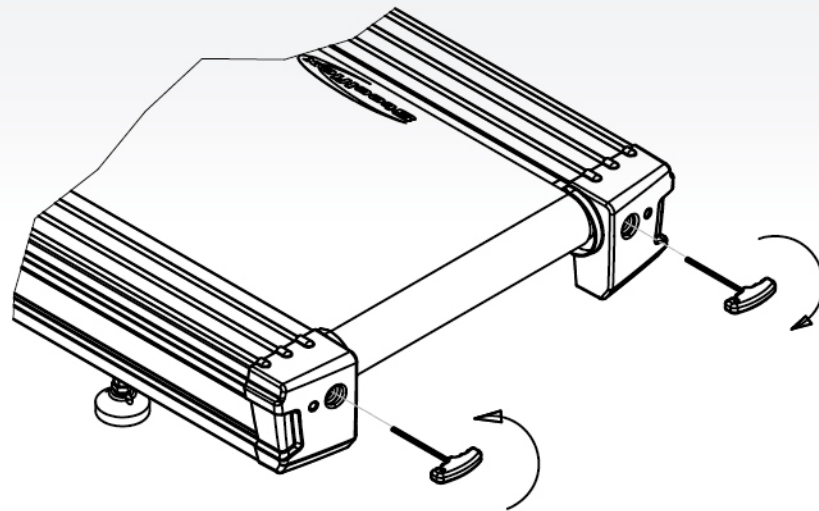

TENSIONING THE BELT

Running Belt

If when you plant your foot on the belt, you can feel a slipping sensation then the belt has been stretched and is slipping over the roller.

This is normal and common adjustment on a new treadmill.

To eliminate this slipping, tighten both sides of the rear roller by using an Allen wrench to turn $1/4$ of a TURN as shown above. Try the treadmill again to check for slipping.

Repeat if necessary, but NEVER TURN the roller bolt more than $1/4$ turn at a time.

CAUTION : OVER TIGHTENING OF THE ROLLER WILL SEVERELY SHORTEN THE LIFE OF THE BELT AND MAY CAUSE FURTHER DAMAGE TO OTHER COMPONENTS.

Drive Belt

If you have tightened the running belt and are still experiencing a slipping sensation, call your Dealer.

Tightening of the drive belt should only be performed by an authorized dealer.

OPERATING INSTRUCTIONS FOR PT7/PT10

Display instruction

The display layout for your PT10 & PT7 includes information windows, matrix window and button location.

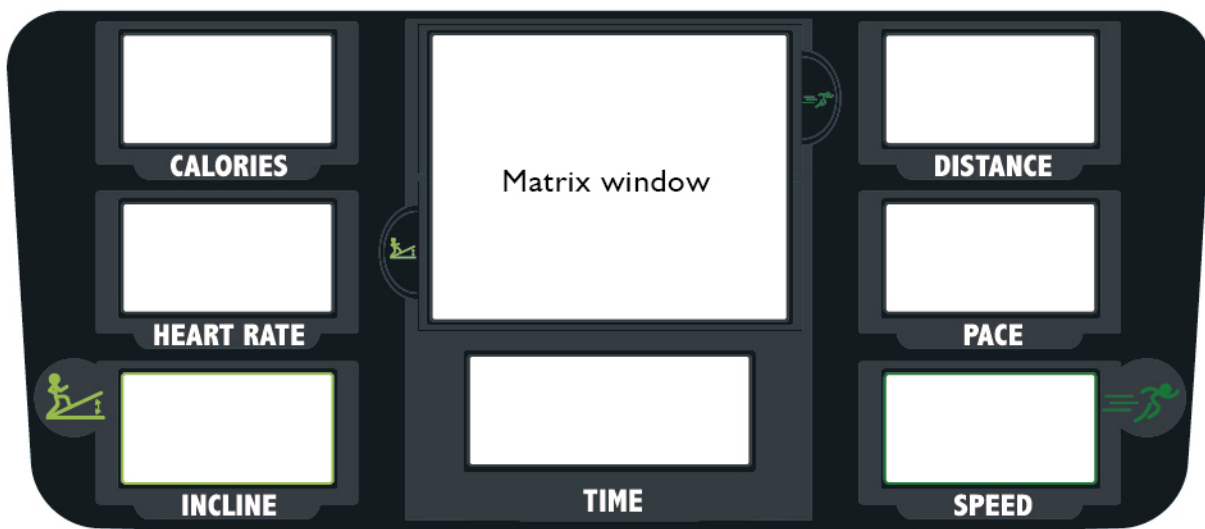

▲ Information Window

▼ Button Location



INFORMATION WINDOW

The information window provides user workout data which includes:







User workout data	Description
TIME	Indicates time in minutes and seconds (mm:ss).
HEART RATE	Indicates heart rate beats per minute during your workout. (Only displayed if you are using contact heart rate bar or chest belt.)
CALORIES	Indicates accumulated calories burned during your workout.
INCLINE	Indicates current incline of your workout.
DISTANCE	Indicates distance of workout.
PACE	Indicates time required per mile or kilometer.
SPEED	Indicates speed of your workout. (Either miles or kilometers.)











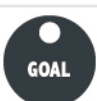
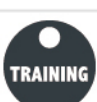

Matrix window

The Matrix Window displays the workout program you select. Each program displays a different exercise profile. Flashing lamp bar in the window displays your location on the exercise course.

Buttons Location

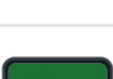







There are buttons for operating the machine, adjusting incline level, and adjusting exercise speed. A description of each button is listed below.

	Start workout
	Enter Data
	Stop workout slowly
	Stop workout
	Adjust workout level
	Adjust incline level. Every press will increase/decrease 1 level. Press and hold the button to adjust quickly.
	Adjust speed. Every press will increase/decrease 0.1 mile. Press and hold button to adjust in 1.0 increments.





	Adjust fan strength. There are three adjustments: off, Low and High. Fan can be used only when safety key is attached.
	Choose CLASSIC exercise programs which include CARDIO, FAT BURN, and INTERVAL.
	Choose Heart rate control exercise programs which include TARGET, HILL, and INTERVAL.
	MANUAL program.
	Choose GOAL exercise programs which include TIME, DISTANCE and CALORIES.
	Choose TRAINING exercise programs which include GERKIN, USB, CUSTOM 1, CUSTOM 2 and CUSTOM 3.
	REVERSE program which belt runs backward. (Only for PT10)
	Elevation quick key for 0.
	Elevation quick key. Level 8 for GEN mode and Level 3 for SIL mode.
	Elevation quick key. Level 15 for GEN mode and Level 6 for SIL mode.
	Speed quick key. 2.5 MPH for GEN mode and 1.5 MPH for SIL mode.
	Speed quick key. 3.5 MPH for GEN mode and 2.5 MPH for SIL mode.
	Speed quick key. 4.5 MPH for GEN mode and 3.5 MPH for SIL mode.

SETTINGS

1. PT7 & PT10 are designed for general market(GEN mode) and Rehab. Geriatric market(SIL mode). User can switch modes by following steps.

step 1	Remove safety key.	
step 2	Press and hold “  ” and “  ” for 3+ seconds.	
step 3	Put safety key back and press “   ” to choose GEN or SIL mode. Then press “  ”.	
step 4	Press “  ” to go back exercise mode.	Keep pressing “   ” to choose “MPH” or “KM”, and then press “  ”.
step 5	Light test scan, and then it will go back to exercise mode directly.	









2. Date setting

step 1	Turn on the treadmill.
step 2	Press “  ” and hold for 3 seconds.
step 3	Set year and adjust by “   ”, then press “  ”.
step 4	Set month and adjust by “   ”, then press “  ”.
step 5	Set date and adjust by “   ”, then press “  ”.
step 6	Set hour and adjust by “   ”, then press “  ”.
step 7	Set minute and adjust by “   ”, then press “  ” to back to exercise window.

Programs

There are different exercise programs, includes MANUAL, CLASSIC, H.R.C, GOAL, TRAINING and REVERSE. Operations are explained as follows.

Manual

<p>step 1</p>	<p>Turn on the power, Steelflex PT7 or Steelflex PT10 scrolls. Press “  ”, the matrix window shows 154LBS . User can adjust weight by pressing any “  ” and “  ” , then press “  ” or press “  ” to begin.</p>
<p>step 2</p>	<p>Press “  ”, and then press “  ” . Or press “  ” to begin.</p>

Note: During workout, user can change speed and incline by

using “  ” and “  ” .









GOAL

step 1	Set weight by pressing “  ” or “  ” .
step 2	Press “  ” .
step 3	Pressing “  ” or “  ” to set TIME, DISTANCE or CALORIES and then press “  ” .
step 4	Adjust workout time, distance or calories by press “  ” or “  ” .
step 5	Press “  ” .

Note: During workout, user can change speed and incline by

using “  ” and “  ” .















CLASSIC

step 1	Set weight by pressing “  ” or “  ” .
step 2	Press “  ” .
step 3	Pressing “  ” or “  ” to choose CARDIO, FAT BURN or INTERVAL program and then press “  ” .
step 4	Adjust workout time by press “  ” or “  ” .
step 5	Press “  ” .











Note: During workout, user can change speed and incline by

using “  ” and “  ” .

H.R.C.

step 1	Set weight by pressing “  ” or “  ”.	
step 2	Press “  ”.	
step 3	Press “  ” or “  ” to choose TARGET, HILL or INTERVAL program and then press “  ”.	
step 4	Press “  ” or “  ” to set AGE and then press “  ”.	
step 5	Choose TARGET program	Choose HILL or INTERVAL program
	Press “  ” or “  ” to set MAX H.R.% and then press “  ”.	Press “  ” or “  ” to set workout time, and then press “  ”.



TRAINING

step 1	Set weight by pressing “  ” or “  ”.
step 2	Press “  ”.
step 3	<p>Press “  ” or “  ” to choose GERKIN, USB, CUSTOM1, CUSTOM 2 or CUSTOM 3 and then press “  ”.</p> <p>Press “  ” or “  ” to change time, and then press “  ”.</p>
step 4	Press “  ”.





Note: During workout, user can change speed and incline by

using “  ” and “  ”.

REVERSE (Only for PT10)



step 1	Set weight by pressing “  ” or “  ”.
step 2	Press “  ”.
step 3	Press “  ”.

Note:

1. Under REVERSE program, max. speed is 3 MPH.
2. When exercising, user can change speed and incline by pressing “  ” and “  ”.
3. When exercising, “  ”, “  ” and “  ” speed quick key are locked.

User can not change speed by pressing these three buttons.

4. When REVERSE program finishes, if user wants to choose other program, user have to press and hold “  ” to back to standby mode.

1. When pressing “  ”, speed and elevation decrease to 0 slowly.
2. When pressing “  ”, speed decreases to 0 MPH, but elevation will not change.
3. All exercise information will be kept for 5 minutes after exercising. After 5 minutes, it will turn to standby mode.
4. Under standby mode, if no operation in 5 minutes, it will turn to sleep mode which turns off display. Press any button to leave sleep mode.

ERROR CODE

1. When the display shows E1, indicates Drive Motor Error.
2. When the display shows E6, indicates an elevation motor signal error.
3. When the display shows E7, indicates elevation motor error.
4. When the display shows USB ERR, USB is not detected.
5. When the display shows USB DATA ERR, it means USB format mistake. Please re-check if data format is correct.

PT7 / PT10 USB USER MANUAL

Before using USB function of PT7 and PT10 correctly, please install Steelflex USB program in your computer first.

I. How to set up program?

a. Edit window

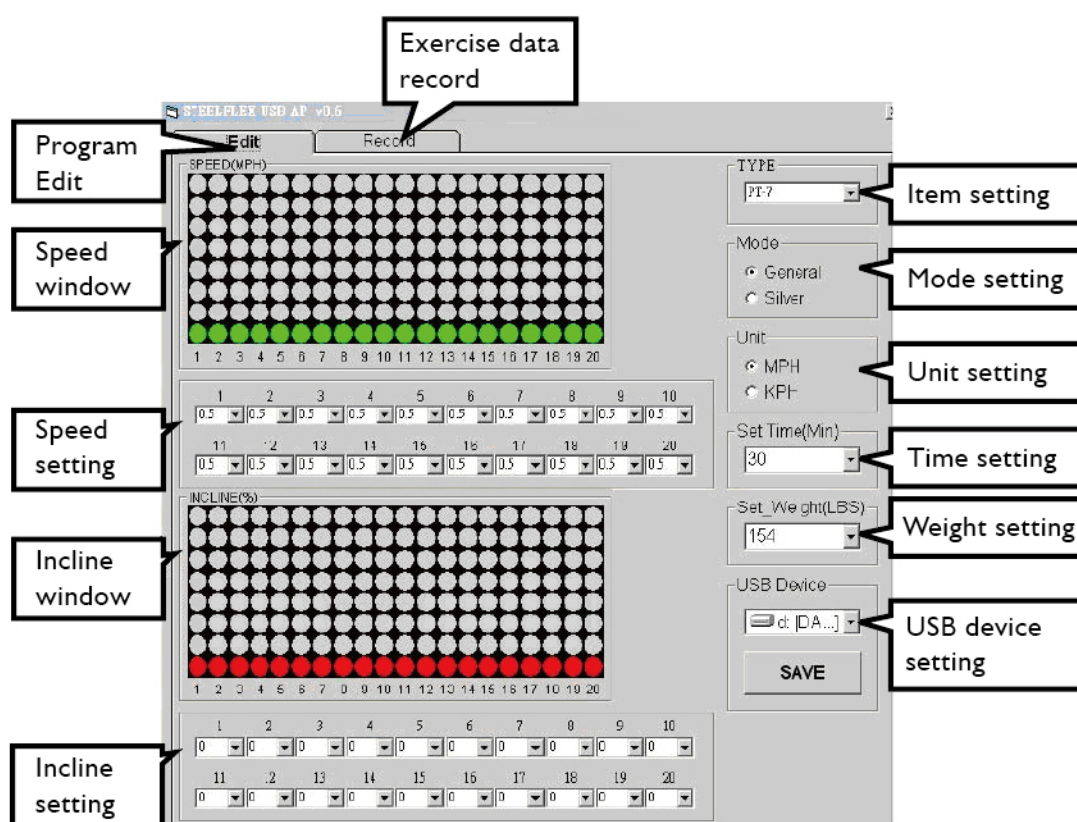

b. Operation

1. Set each bar of speed and incline by pressing arrows in each segment.
2. Graph in Speed window and Incline window will be changed.
3. Speed and Incline can be set by pressing each bar of speed window and incline window.

4. After setting, please press SAVE. The file will be saved in the USB device where you choose. File name in the computer will be PT10. CUS or PT7. CUS and it can not be changed. Different name can not be read by treadmill.
5. If data setting is over range, it will show “DAT ERR” on treadmill console.

Note: Please notice, TYPE on USB operating window needs to be the same as your treadmill, or the function will not work properly.

3. How to use Exercise Data Record?

a. Record window

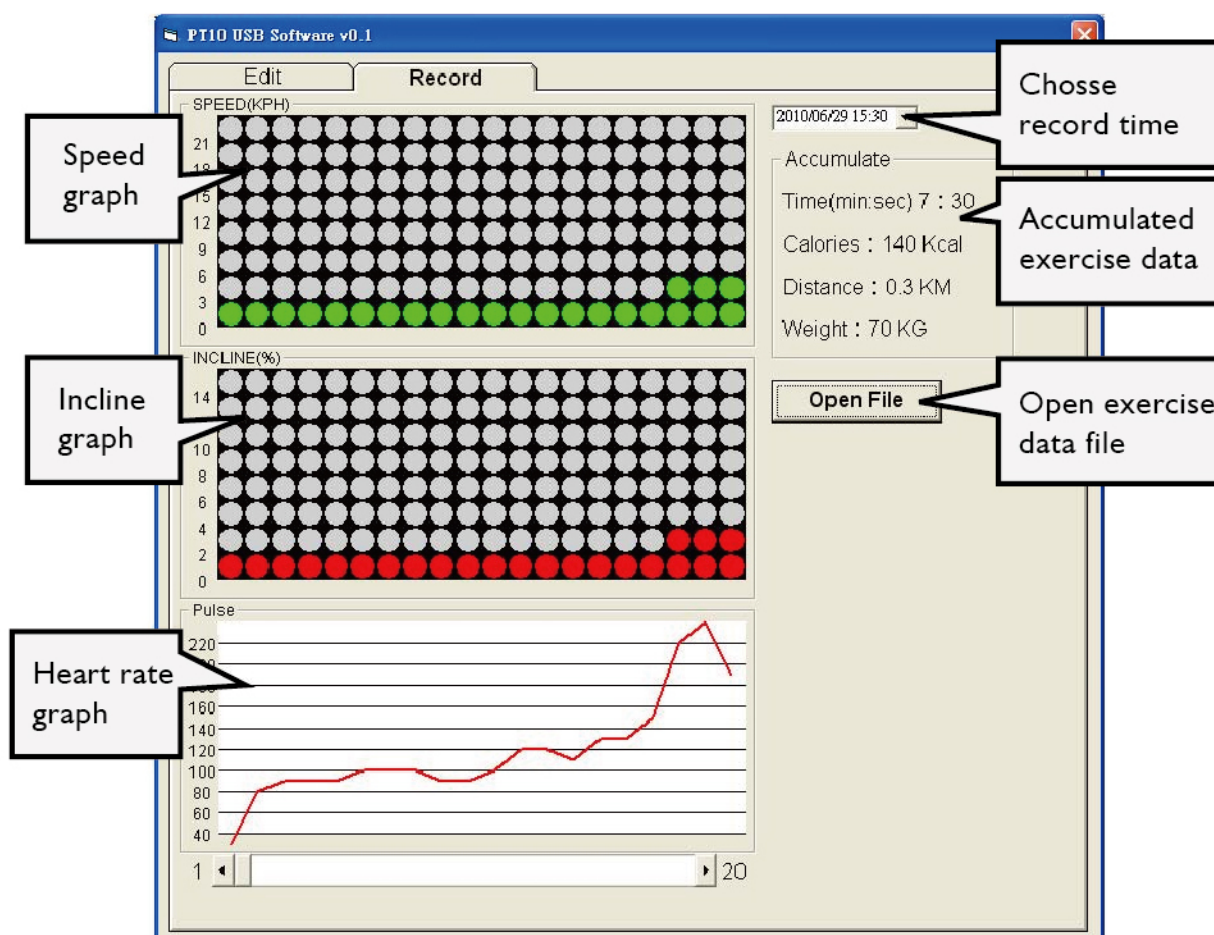

PT7 RUN BELT ADJUSTMENT

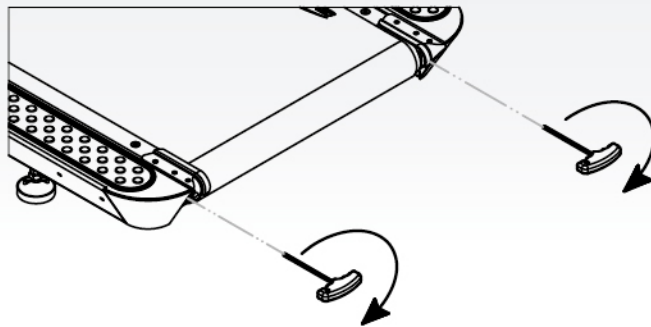

After assembly and before turning power on position the rear roller using the ' T ' wrench (refer to the drawing if needed) . make 3 turns clockwise to avoid the belt from slipping.

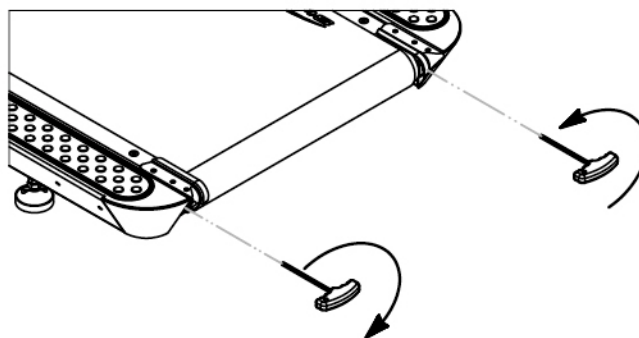

If belt is too far to the left side

- 1)turn the left roller bolt 1/4 turn clockwise(tighten)
- 2)turn the right roller 1/4 turn counterclockwise(loosen)

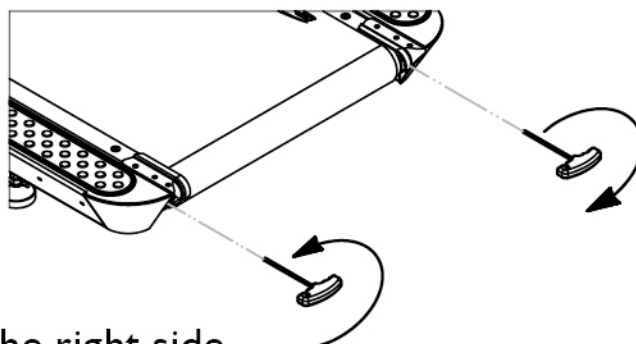

If belt is too far to the right side

- 1)turn the right roller bolt 1/4 turn clockwise(tighten)
- 2)turn the left roller bolt 1/4 turn counterclockwise(loosen)

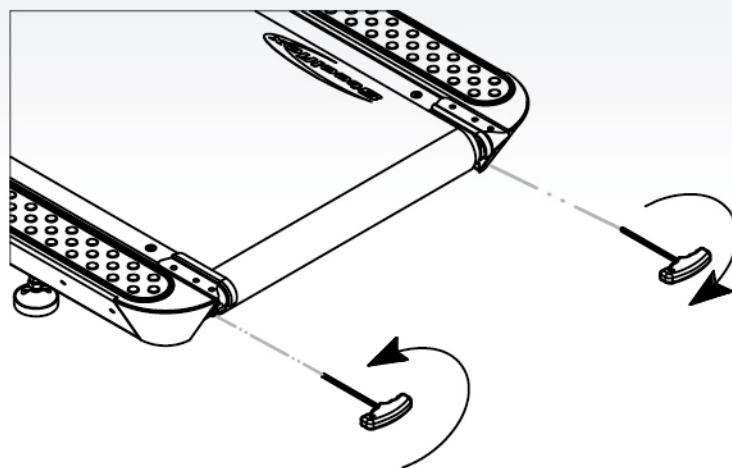

TENSIONING THE BELT

Running Belt

If when you plant your foot on the belt, you can feel a slipping sensation then the belt has been stretched and is slipping over the roller.

This is normal and common adjustment on a new treadmill.

To eliminate this slipping, tighten both sides of the rear roller by using an Allen wrench to turn $1/4$ of a TURN as shown above. Try the treadmill again to check for slipping.

Repeat if necessary, but NEVER TURN the roller bolt more than $1/4$ turn at a time.

CAUTION : OVER TIGHTENING OF THE ROLLER WILL SEVERELY SHORTEN THE LIFE OF THE BELT AND MAY CAUSE FURTHER DAMAGE TO OTHER COMPONENTS.

Drive Belt

If you have tightened the running belt and are still experiencing a slipping sensation, call your Dealer. Tightening of the drive belt should only be performed by an authorized dealer.

PT10 RUN BELT ADJUSTMENT

To protect run belt quality, when assembling in the factory, run belt is not in tightened situation. After installation the treadmill and before workout, please follow the steps to adjust. Meanwhile, when replacing new run belt, run deck and rear roller, please also follow the steps to adjust.

Step 1:

Uninstall right and left rear end caps.

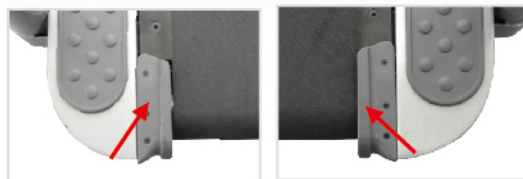

Step 2:

Please use spanner(M8L) to turn screws as picture shows 3 circles clockwise.

Notice:

Please do not let run belt rubs parts in sides to prevent from run belt damages.

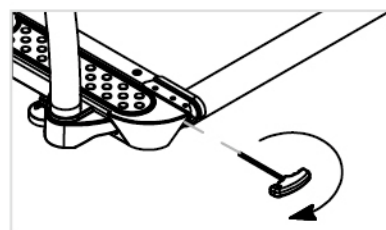

Step 3:

Turn on the treadmill. Press MANUAL program and start the treadmill. Adjust speed to 4 MPH(or 6 KPH) to make the treadmill runs for 1 minute without people on it and ensure run belt doesn't rub parts in sides. Then, turn the speed to 15 MPH(or 24 KPH) to make the treadmill runs for another 1 minutes without people on it and ensure the run belt stays in the center.

Step 3a:

If run belt shifts to left side lots, please use spanner(M8L) and follow below information to adjust.

- Turn left side screw 1/4 circle clockwise.
- Turn right side screw 1/4 circle counter clockwise.

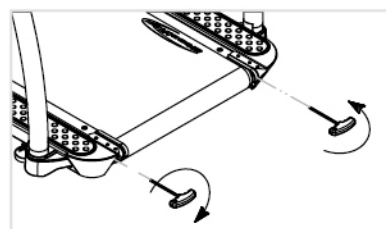

Step 3b:

If run belt shifts to right side lots, please use spanner(M8L) and follow below information to adjust.

- Turn right side screw 1/4 circle clockwise.
- Turn left side screw 1/4 circle counter clockwise.

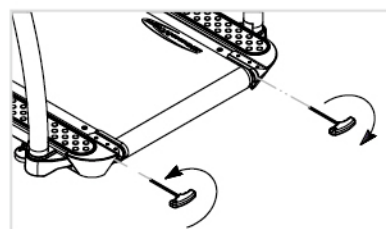

Notice:

Step 3a or step 3b are needed only when run belt shifts to right or left lots.

Step 4:

Decrease the speed which allows people to run or walk, and feel if run belt slips. If run belt slips, please use spanner(M8L) to turn screws 1/4 circle clockwise.

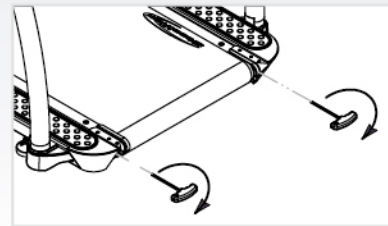
**Notice:**

The run belt can not be over tightened; otherwise, run belt life will be shortened.

Step 5: (run belt reverse adjustments)

Please check if 2 threads of the bolt which is pointed by arrow in the picture is out of the nut and can be seen. (Both right and left sides need to be checked.)

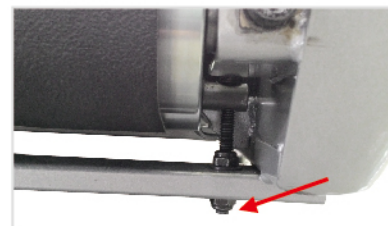
**Step 6:**

If you can not see 2 threads of the bolt out of the nut in step 5, please use T wrench to fix the screw as picture I shows. Use wrench to turn nut(B) counter clockwise to loose until 2 threads of the bolt is out of nut(A) and can be seen. Use wrench to tighten the bolt as picture I shows and fix. Use wrench to tighten nut(B). Then take off the T wrench which uses to fix the screw.

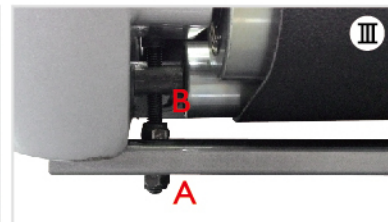
**Notice:**

Both left and right sides must be checked and done.

Step 7a:

If run belt shifts to left, please use T wrench to fix left side bolt as picture I & II shows to prevent from turning when adjusting. Use wrench to turn nut(B) of left side counter clockwise to loose (picture III). Then turning T wrench counter clockwise (picture IV). How many turns are needed? Depends on how far the run belt shifts. Once the run belt is in the center, use wrench to tighten the nut(B). And take off the T wrench which was used to fix.

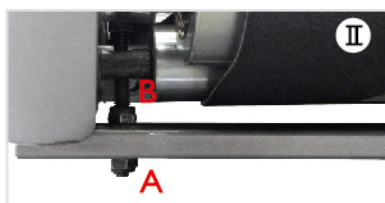

Step 7b:

If run belt shifts to right, use T wrench to fix in the right as picture shows. Use wrench to turn nut(B) of right side counter clockwise to loose. Then turning T wrench counter clockwise. How many turns are needed? Depends on how far the run belt shifts. Using wrench to tighten nut(B) Then take off the T wrench which was used to fix.

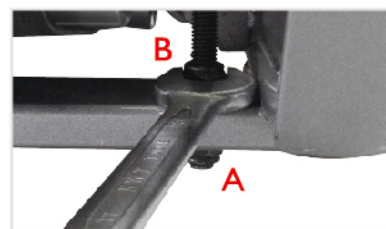
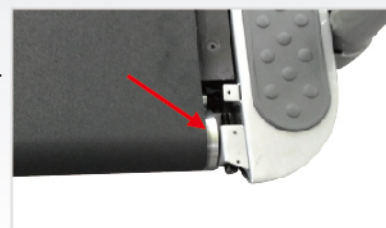
**Step 8:**

Turn on the treadmill. Press MANUAL program and start the treadmill. Adjust speed to 4 MPH (or 6 KPH) to make the treadmill runs for 1 minute without people on it and ensure run belt doesn't rub parts in side. Then, turn the speed to 15 MPH(or 24 KPH) to make the treadmill runs for another 1 minutes without people on it and ensure the run belt stays in the center. If the run belt is not in the center, please follow step 3a or step 3b to adjust.

Step 9:

Press REVERSE program and start the treadmill. Adjust speed to 4MPH (or 6 KPH) to make the treadmill runs for 1 minute without people on it and ensure run belt is in the center. If the run belt shifts, please follow step 7a or 7b to adjust again until the run belt stays in the center.

Step 10:

Decrease the speed which allows people to run or walk, and feel if run belt slips. If run belt slips, please use spanner(M8L) to turn screws as left picture shows 1/4 circle clockwise.

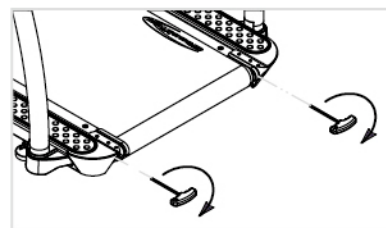

Install right and left side rear end caps back.

OPERATING INSTRUCTION FOR XT8000A & XT8000D

Display instruction

The display layout for your XT8000A & XT8000D includes information window, matrix window and button location.



▲ Information Window

▼ Button Location



INFORMATION WINDOW

INFORMATION WINDOW

Information window provides user workout data which includes:

User information Data	Description
TIME	Indicates time in minutes and seconds(mm:ss)
CALORIES	Indicates accumulated calories burned during workout.
DISTANCE	Indicates distance of workout.
PULSE	Indicates heart rate beats per minute during workout. (Only displayed if you are using contact heart rate bar or chest belt.)
ELEVATION	Indicates current incline of your workout.
SPEED	Indicates speed of your workout. (Either miles or kilometers.)
PACE	Indicates time required per mile or kilometer.











Matrix Window

The Matrix Window displays the workout program you select. Each program displays a different exercise profile. Flash lamp bar in the window displays your location on the exercise course.

OPERATING INSTRUCTIONS FOR XT8000A/D

Button Location







There are buttons for operating the machine, adjusting incline level, and adjusting exercise speed. A description of each button is listed below.

	Start workout.		Enter data.
	Stop workout.		Reset APP connect (Bluetooth).
	Stop workout slowly.		Adjust workout level.
	Adjust incline level. Each press will increase/decrease 1 level. Press and hold the button to adjust quickly.		
	Adjust speed. Each press will increase/decrease 0.1. Press and hold the button to adjust quickly.		
		Incline quick key.	
		Speed quick key.	









Programs

There are different exercise programs, includes manual, interval, walking, running, weight loss, cardio, L.S.D., set calories, custom learn and heart rate control. Operations are explained as below.











Manual

step 1	Turn on the power and press “  ” or “  ” to set weight and press “  ”. The default value is 176 LBS.
step 2	Press “  ” or “  ” to choose MANUAL program and press “  ”.
step 3	Press “  ”.

Interval

step 1	Turn on the power and press “  ” or “  ” to set weight and press “  ”. The default value is 176 LBS.
step 2	Press “  ” or “  ” to choose INTERVAL program and press “  ”.
step 3	Press “  ” or “  ” to set sprint distance, then press “  ”. There are 3 different sprint distances which are 0.12 mile (0.2 km), 0.24 mile (0.4 km) and 0.5 mile (0.8km).









Interval

step 4	Press “  ” or “  ” to set sprint speed, then press “  ”. (Lowest sprint speed must be 5 MPH / 8 KPH)
step 5	Press “  ” or “  ” to set repeat times, then press “  ”.
step 6	Press “  ” or “  ” to set sets, then press “  ”.
step 7	Press “  ”.

	Warm up		Sets 1				Sets N				Cool down			
			Repeat 1		Repeat N		Repeat 1		Repeat N				
Speed	50%	75%	100% (sprint)	60%		100% (sprint)	60%		100% (sprint)	60%		100% (sprint)	60%	60%	50%
Time	3 min	9 min												3 min	5 min
Sprint distance (mile/km)			0.12/ 0.2	0.06/ 0.1		0.12/ 0.2	0.06/ 0.1		0.12/ 0.2	0.06/ 0.1		0.12/ 0.2	0.06/ 0.1		
Sprint distance (mile/km)			0.24/ 0.4	0.12/ 0.2		0.24/ 0.4	0.12/ 0.2		0.24/ 0.4	0.12/ 0.2		0.24/ 0.4	0.12/ 0.2		
Sprint distance (mile/km)			0.5/ 0.8	0.25/ 0.4		0.5/ 0.8	0.25/ 0.4		0.5/ 0.8	0.25/ 0.4		0.5/ 0.8	0.25/ 0.4		











I. During warm up, you can press “  ” any time to skip warm up and start INTERVAL program.

Walking / Running / Weight loss / Cardio

step 1	Turn on the power and press “  ” or “  ” to set weight and press “  ”. The default value is 176 LBS.
step 2	Press “  ” or “  ” to choose WALKING / RUNNING / WEIGHT LOSS / CARDIO program and press “  ”.
step 3	Press “  ” or “  ” to set time.
step 4	Press “  ”.

1. During workout, you can press “  ” to adjust workout level.
2. During workout, you can adjust speed and incline.









L.S.D.

step 1	Turn on the power and press “  ” or “  ” to set weight and press “  ”. The default value is 176 LBS.
step 2	Press “  ” or “  ” to choose L.S.D. program and press “  ”.
step 3	Press “  ” or “  ” to set distance. 3 miles / 5K, 6 miles / 10K, 9 miles / 15K, 12 miles / 20K can be chosen.
step 4	Press “  ” or “  ” to set speed. Lowest speed is 5 MPH(8 KPH).
step 5	Press “  ”.

SPEED	WARM UP			COOL DOWN	
	50%	75%	100%	60%	50%
Distance 3Mile / 5 K	3 min	3 min	3 Mile / 5 K	3 min	1 min
Distance 6Mile / 10 K	3 min	9 min	6 Mile / 10 K	3 min	5 min
Distance 9Mile / 15 K	3 min	15 min	9 Mile / 15 K	3 min	9 min
Distance 12Mile / 20 K	3 min	21 min	12 Mile / 20 K	3 min	13 min















I. During workout, you can adjust speed and incline.

Set Calories

















<p>step 1</p>	<p>Turn on the power and press “  ” or “  ” to set weight and press “  ”. The default value is 176 LBS.</p>
<p>step 2</p>	<p>Press “  ” or “  ” to choose SET CALORIES program and press “  ”.</p>
<p>step 3</p>	<p>Press “  ” or “  ” to set calories.</p>
<p>step 4</p>	<p>Press “  ”.</p>

1. During workout, you can adjust speed and incline.

Custom Learn









step 1	<p>Turn on the power and press “  ” or “  ” to set weight and press “  ”.</p> <p>The default value is 176 LBS.</p>
step 2	<p>Press “  ” or “  ” to choose CUSTOM LEARN program and press “  ”.</p> <p>There are 2 custom learn programs. You can choose 1 or 2 to set.</p>
step 3	<p>Press “  ” to set each segment’s speed.</p> <p>Press “  ” to set each segment’s incline.</p> <p>When the segment is set, please press “  ” to set next segment. If you need to change last segment setting, please press “  ” . When all are set, please press “  ” .</p> <p>While setting, you can also press “  ” to skip settings.</p>
step 4	<p>Press “  ” or “  ” to set time.</p>
step 5	<p>Press “  ”.</p>

HEART RATE CONTROL

step 1	Turn on the power and press “  ” or “  ” to set weight and press “  ”. The default value is 176 LBS.
step 2	Press “  ” or “  ” to choose HEART RATE CONTROL program and press “  ”.
step 3	Press “  ” or “  ” to set time and press “  ”.
step 4	Press “  ” or “  ” to set age and press “  ”. Default value is 30.
step 5	Press “  ” or “  ” to set target heart rate and press “  ”. Default value is 70%.
step 6	Press “  ”.

- 1.If heart rate is less than target value over 10 bpm, elevation increases 1% every 30 seconds. If heart rate more than target value over 10 bpm, elevation decreases 1% every 30 seconds.
- 2.If heart rate can not be detected for 30 seconds, program ends.

ENGINEER MODE

1. Press and hold “  ” and speed “  ” for few seconds to enter engineer mode.
2. 「PANEL VER x.xx」 is showed, then press “  ”.
3. 「MCB VER xxxx」 is showed, then press “  ”.
4. 「SET UNIT=MILE/KM」 is showed, then press “  ”.
5. 「TIME = xxxx」 is showed, then press “  ”.
This is accumulated exercise time of the unit.
6. 「DISTANCE = xxxx」 is showed, then press “  ”. This is accumulated exercise distance of the unit.
(Accumulated time and distance can be clear by pressing and hold “  ” and “  ” for few seconds.)

NOTICE

When turn on the treadmill, if the console shows “SPRAY OIL”, please follow run belt maintenance step (P55-56) to spray silicone lubricant. After spraying, please enter engineer mode to clear accumulated distance, “SPRAY OIL” of the consloe can be clear.

NOTICE OF APP

- 1.APP can only work after connecting with XT8000A/D
- 2.Above 720*1280 dpi is suitable.
- 3.Request Andround 4.3 or above/Bluetooth V4.0.

XT8000 RUN BELT ADJUSTMENT

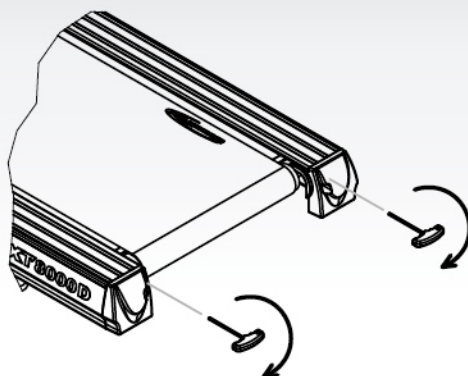

After assembly and before turning power on position the rear roller using the ' T ' wrench (refer to the drawing if needed) . make 3 turns clockwise to avoid the belt from slipping.

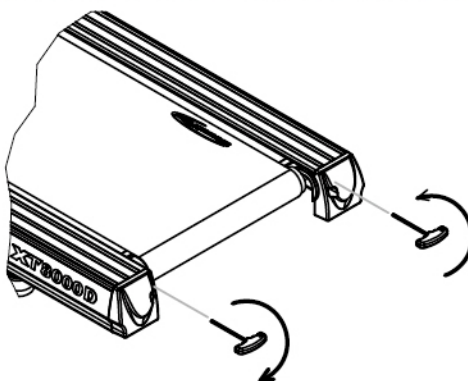

If belt is too far to the left side

- 1)turn the left roller bolt 1/4 turn clockwise(tighten)
- 2)turn the right roller 1/4 turn counterclockwise(loosen)

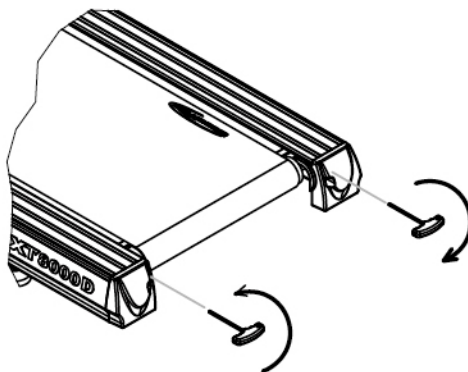

If belt is too far to the right side

- 1)turn the right roller bolt 1/4 turn clockwise(tighten)
- 2)turn the left roller bolt 1/4 turn counterclockwise(loosen)

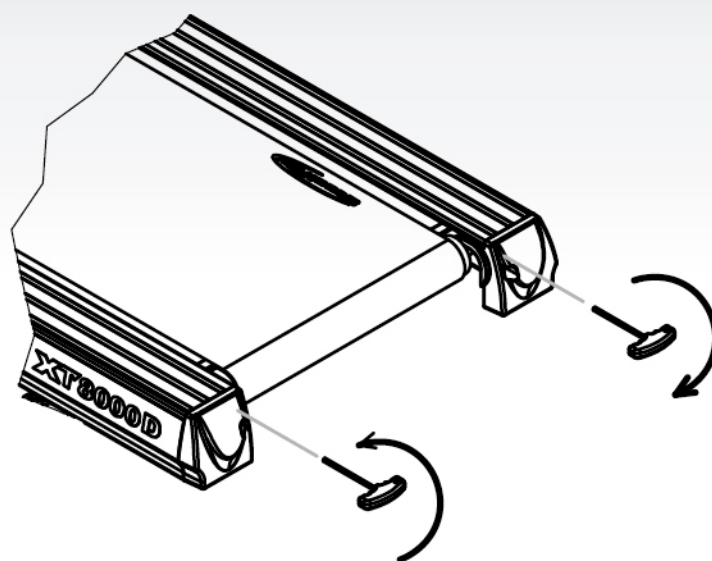

TENSIONING THE BELT

Running Belt

If when you plant your foot on the belt, you can feel a slipping sensation then the belt has been stretched and is slipping over the roller.

This is normal and common adjustment on a new treadmill.

To eliminate this slipping, tighten both sides of the rear roller by using an Allen wrench to turn $1/4$ of a TURN as shown above. Try the treadmill again to check for slipping.

Repeat if necessary, but NEVER TURN the roller bolt more than $1/4$ turn at a time.

CAUTION : OVER TIGHTENING OF THE ROLLER WILL SEVERELY SHORTEN THE LIFE OF THE BELT AND MAY CAUSE FURTHER DAMAGE TO OTHER COMPONENTS.

Drive Belt

If you have tightened the running belt and are still experiencing a slipping sensation, call your Dealer .

Tightening of the drive belt should only be performed by an authorized dealer.

Steps for spray lubricant on the run belt

Step 1:

Power off.

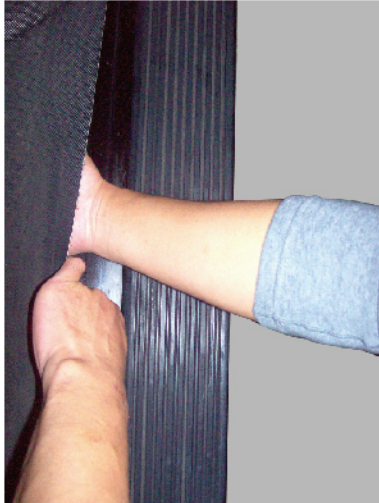

Step 2:

Inspect run belt situation. Lift run belt as left picture shows. Touch running area's back of run belt by hand to feel if lubricant enough on the back of run belt. If run belt needs to be lubricated, please take a wiper to clean run deck and roller.



Step 3:

Lift right side belt and spray lubricant as left picture showed. When spraying, the hand lifts the run belt needs to pull the run belt and make the run belt turn until run belt turns a revolution.

Notice:

When spray lubricant, please spray in center area. Please don't spray in side area.

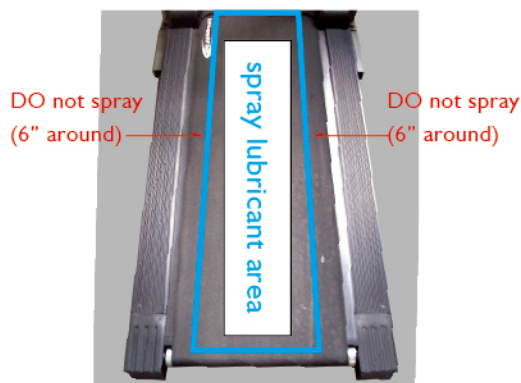

Steps for spray lubricant on the run belt

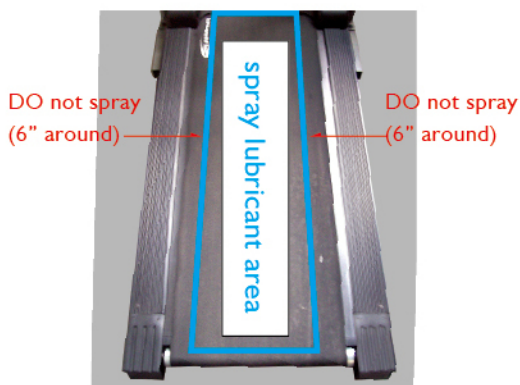
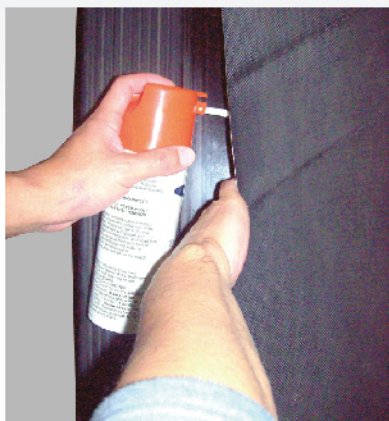

Step 4:

Lift left side belt and spray lubricant as left picture showed. When spraying, the hand lifts the run belt needs to pull the run belt and make the run belt turn until run belt turns a revolution.

Notice:

When spray lubricant, please spray in center area. Please don't spray in side area.

Step 5: Power on.

Press "START", and increase speed to IMPH(1.6 KPH). Have a people walk on the treadmill to help run belt absorbs.

Please notice:

DO NOT make the treadmill run in high speed when just spray lubricant. If lubricant is not absorbed, lubricant will spray out to drive motor and MCB.

Remark:

- 1.For each time maintenance, spray 30-50 cc. lubricant is suggested.
- 2.Suggested time to spray lubricant:
 - a.Accumulated distance is 1250 miles (2000 km).
 - b.Accumulated workout time is 50 hours.

MAINTENANCE

All Steelflex series products are designed for heavy usage environment. To keep your Steelflex product in good condition, we strongly recommend some preventative maintenance tips.

Cleaning

When cleaning the exterior of the unit, a non-abrasive cleanser and soft cotton cloth are strongly recommended. At no time should cleaner be applied directly to any part of the equipment. Instead, place the non-abrasive cleaning solution on a soft cloth and wipe down the unit.

- Clean the console and all exterior surface regularly.
- Vacuum running belt regularly to keep debris from accumulating
- Inspect exterior parts regularly for wear and tear, especially the running belt and deck
- Inspect area under treadmill and vacuum regularly.

Item	Daily	Weekly	Monthly	Quarterly	Bi-Annual	Certain time
Console Mounting Bolt					Inspect	
Frame	Clean				Inspect	
Console	Clean		Inspect			
Safety Stop	Test					
Power Cord			Inspect			
Run Belt Top		Clean (Vacuum)				
Run Belt Tension			Inspect			
Run Belt Lubricant						1.Accumulated distance: 1250mile(2000km). 2.Accumulated workout time: 50 hours.
Rear Adjustable Foot				Adjust		
V Belt				Adjust		
Motor Pulley				Clean		

WARNING

Always disconnect power before cleaning or working on treadmill.

WARRANTY

WARRANTY CONDITIONS

1. The warranty applies only to the original owner, and covers the cost of parts repair or replacement and does not include freight charges. Proof of purchase must be demonstrated.
2. The warranty applies only to the original owner and is non transferable.
3. If you are in US, please contact your local dealer or FMI for details of warranty. If you are in other countries, please contact your local dealer or JCI for details of warranty .
4. Labor coverage is provided only by authorized dealer or by factory authorization.
5. Any reimbursement for travel outside of the dealers' normal service or coverage area will be the responsibility of the customer.
6. Warranty does not cover failure due to improper assembly, installation or use.
7. This warranty does not cover customer instruction, installation, set up or adjustment. User is responsible for reasonable and necessary maintenance.
8. The warranty will not be extended to any product whose serial number has been removed, altered, or defaced.
9. This warranty does not cover damage or equipment failure caused by, or resulting from accident, misuse, abuse, improper assembly or installation, un-authorized modification, or failure to provide reasonable and necessary care as outlined in the owner's manual.
10. If you are in US, this warranty becomes **VALID ONLY** when are warranty registration form included, is completely filled in, signed by the original owner and received by FMI **WITHIN 30 DAYS** of the purchaser's receipt of the product. If your are outside of the US, please contact your local dealer.

CARDIO
CARDIO

Steelflex

Designed for enjoying your life

USER MANUAL V.7