

Body-Solid®

Built for Life

my workout.
my schedule.
my life.



EXERCISE CHART

CHEST

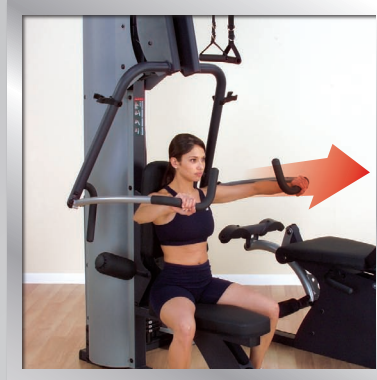

- Chest Press** (pectorals)
1. Insert pin into weight stack at desired resistance level.
 2. Set back pad to the Flat Chest Press position **A**.
 3. Sit comfortably on the seat pad with your back flat against the back pad.
 4. Grasp horizontal press handles with your arms bent and palms facing downward.
 5. Keeping your elbows out and below your shoulders, extend your arms straight forward at a smooth, moderate pace throughout the exercise movement.
 6. Pause for a moment, then slowly return to the starting position. Repeat movement.
 7. Exhale on exertion, inhale on return motion.



- Incline Press** (pectorals)
1. Insert pin into weight stack at desired resistance level.
 2. Set back pad to the Incline Press position **B**.
 3. Sit comfortably on the seat pad with your back flat against the back pad.
 4. Grasp horizontal press handles with your arms bent and palms facing downward.
 5. Keeping your elbows out and below your shoulders, extend your arms straight forward at a smooth, moderate pace throughout the exercise movement.
 6. Pause for a moment, then slowly return to the starting position. Repeat movement.
 7. Exhale on exertion, inhale on return motion.



- Pectoral Fly** (pectorals)
1. Insert pin into weight stack at desired resistance level.
 2. Set back pad to the Flat Pec Fly position **A**.
 3. Sit comfortably on the seat pad with your back flat against the back pad.
 4. Reach back and grasp the vertical press handles on each side.
 5. Use Chest muscle strength to arc your arms forward and toward each other.
 6. Pause for a moment, then slowly return along the same arc, to the starting position. Repeat movement.
 7. Exhale on exertion, inhale on return motion.

SHOULDERS

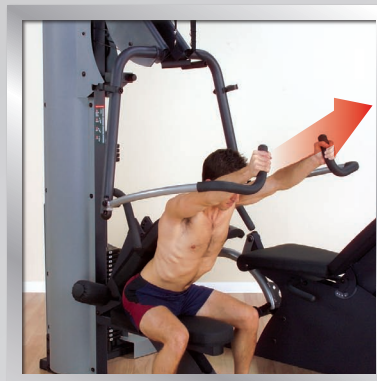

- Shoulder Press** (deltoids)
1. Insert pin into weight stack at desired resistance level.
 2. Set back pad to the Shoulder Press position **C**.
 3. Sit comfortably on the seat pad with your back flat against the back pad.
 4. Grasp vertical press handles at shoulder level. Keep your arms bent and palms facing forward.
 5. Keeping your elbows out, fully extend your arms upward above your head.
 6. Pause for a moment, then slowly return to the starting position. Repeat movement.
 7. Exhale on exertion, inhale on return motion.



- Upright Row** (deltoids & trapezius)
1. Insert pin into weight stack at desired resistance level.
 2. Attach Straight Bar to low pulley cable.
 3. Stand erect, facing machine, with your feet approximately shoulder width apart and grasp the bar with your hands approximately 6 inches apart and your palms facing down.
 4. Straighten your arms and allow the weight to pull your arms straight down.
 5. Keeping your elbows above your hands at all times, slowly pull the bar upward until the back of your hands are even with your chin.
 6. Pause for a moment, then slowly return to the starting position. Repeat movement.
 7. Exhale on exertion, inhale on return motion.



- Lateral Deltoid Raise** (deltoids)
1. Insert pin into weight stack at desired resistance level.
 2. Attach Stirrup Handle (optional) to the low pulley cable.
 3. Stand with your right side toward the machine.
 4. Securely grasp the handle with your right hand and your palm facing down.
 5. Use Shoulder muscle strength to slowly raise the handle upward and outward in a semicircular arc until it is in a position even with your shoulder.
 6. Pause for a moment, then slowly return to the starting position. Repeat movement.
 7. Exhale on exertion, inhale on return motion.
 8. Change hands, turn around, and repeat with the opposite arm.

BACK

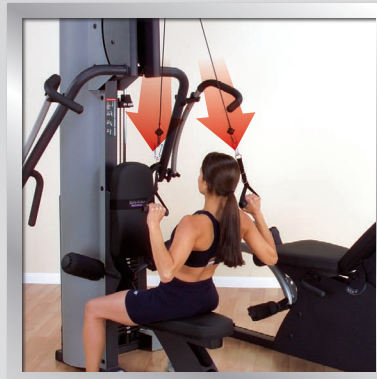

- Lat Pull Down** (latissimus dorsi)
1. Insert pin into weight stack at desired resistance level.
 2. Attach 2 Stirrup Handles to the high pulley cables.
 3. Sit on seat pad facing into machine.
 4. Grasp Handles so your hands are shoulder width apart, and your arms are fully extended above your head.
 5. Keeping your elbows back during movement, slowly pull the Handles down until your hands are even with your chest. Never pull down toward your head or neck.
 6. Pause for a moment, then slowly return to the starting position. Repeat movement.
 7. Exhale on exertion, inhale on return motion.



- Back Hyperextension** (lower back)
1. Insert pin into weight stack at desired resistance level.
 2. Set back pad to the Flat Chest Press position **A**.
 3. Sit facing into the machine and grasp the Mid Row handles.
 4. Keep both your arms and back straight during movement. Slowly lean backward, pivoting at the hips, to a 45° angle, approximately shoulder width.
 5. Pause for a moment, then slowly return to the starting position. Repeat movement.
 6. Exhale on exertion, inhale on return motion.

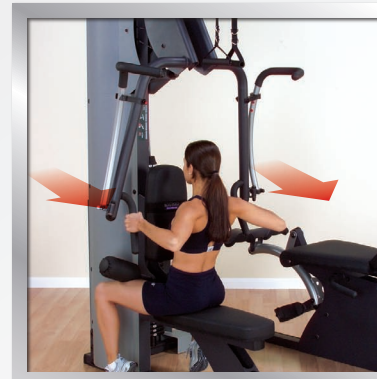

- Chest Supported Mid Row** (latissimus dorsi)
1. Insert pin into weight stack at desired resistance level.
 2. Sit facing into the machine.
 3. Adjust back pad to the Mid Row position **B**. Keep your chest flat against the pad throughout movement.
 4. Grasp the Mid Row handles with both hands allowing the weight to gently stretch your Lats.
 5. Using Upper Back strength pull the handles toward you. Continue to pull the Mid Row handles until they are even with your midsection.
 6. Pause for a moment, then slowly return to the starting position. Repeat movement.
 7. Exhale on exertion, inhale on return motion.

ARMS



- Biceps Curl** (biceps)
1. Insert pin into weight stack at desired resistance level.
 2. Attach Straight Bar to low pulley cable.
 3. Take an underhand grasp on the bar. Stand erect with your feet set at shoulder width and stand approximately 1 to 2 feet away from the machine. Your arms should be down at your sides with the bar resting on your thighs.
 4. Keeping your upper arms locked against the sides of your torso, use Biceps strength to curl the bar upward and forward in a semicircular arc to a position beneath your chin.
 5. Pause for a moment, then slowly return the bar back along the same arc, to the starting position. Repeat movement.
 6. Exhale on exertion, inhale on return motion.

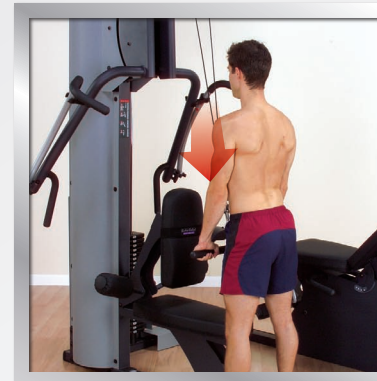

- Triceps Press Down** (triceps)
1. Insert pin into weight stack at desired resistance level.
 2. Attach Straight Bar or 2 Stirrup Handles to the high pulley cables.
 3. Facing the machine, stand erect with your feet set at approximately shoulder width.
 4. Pull the bar/handles and lock your upper arms against the sides of your torso where they must remain throughout the exercise movement. Lean slightly forward at the waist.
 5. Moving only your forearms, use Triceps strength to push the bar/handles downward in a semicircular arc to a position below your waist.
 6. Pause for a moment, then slowly return the bar back along the same arc, to the starting position. Repeat movement.
 7. Exhale on exertion, inhale on return motion.



- Concentration Curl** (biceps)
1. Insert pin into weight stack at desired resistance level.
 2. Attach Stirrup Handle and chain to low pulley cable. Adjust chain for full range of motion.
 3. Take an overhand grasp on the Stirrup Handle with your right hand. Stand approximately 1 to 2 feet from the pulley with your feet at shoulder width. Bend slightly at the waist. Keep your right upper arm locked.
 4. Use Biceps strength to curl the Handle forward and upward in a semicircular arc toward your chest.
 5. Pause for a moment, then slowly return the Handle back along the same arc, to the starting position. Repeat movement.
 6. Exhale on exertion, inhale on return motion.
 7. Change hands and repeat with opposite arm.

ABS

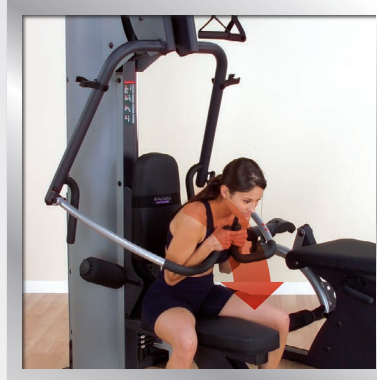

- Resistance Ab Crunch** (abdominals)
1. Insert pin into weight stack at desired resistance level.
 2. Sit on seat pad with your back resting against back pad.
 3. Grasp the vertical press arm handles and rest them against your chest throughout the exercise movement.
 4. Using Abdominal muscle strength, slowly bend forward at the waist as far as comfortably possible.
 5. Pause for a moment, then slowly return back to the starting position. Repeat movement.
 6. Exhale on exertion, inhale on return motion.



- Oblique Crunch** (obliques & abdominals)
1. Insert pin into weight stack at desired resistance level.
 2. Sit on seat pad with your back resting against back pad.
 3. Grasp the vertical press arm handles and rest them against the machine on the foot platform.
 4. Simultaneously bend forward and rotate your upper body slowly to the left as far as comfortably possible while keeping your legs and hips stationary.
 5. Pause for a moment, then slowly return to the starting position.
 6. Alternate the movements from the left to the right and then repeat the movements.
 7. Exhale on exertion, inhale on return motion.

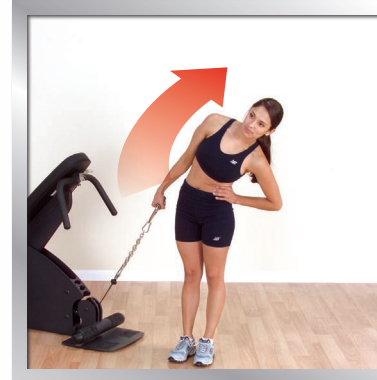

- Oblique Bend** (obliques)
1. Insert pin into weight stack at desired resistance level.
 2. Attach Stirrup Handle and chain to low pulley cable. Adjust chain for full range of motion.
 3. Take an overhand grasp of the strap with your right hand and stand 1 to 2 feet away from the machine with your right side toward the machine.
 4. Keeping your arm, legs, and hips straight, bend your torso away from the machine.
 5. Pause for a moment, then slowly return your torso back along the same arc, to the starting position. Repeat movement.
 6. Exhale on exertion, inhale on return motion.
 7. Turn around and repeat with the opposite hand.

HIPS/THIGHS

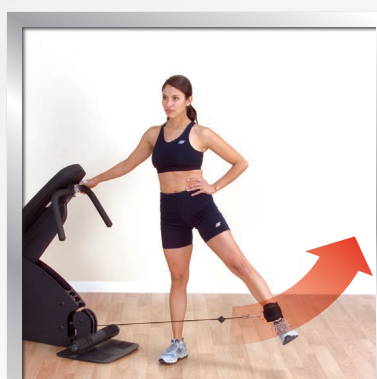

- Leg Abduction** (hip & outer thigh)
1. Insert pin into weight stack at desired resistance level.
 2. Adjust back pad and grasp the Ankle Strap to your left ankle and low pulley cable. Stand 1 to 2 feet away from the pulley with your right side toward the machine.
 3. Keeping your legs straight and body balanced, allow the weight to pull your left leg across your body and toward the machine.
 4. Using Outer Thigh strength, slowly pull your left leg across and away from your body as far as comfortably possible.
 5. Pause for a moment, then slowly return along the same arc, to the starting position. Repeat movement.
 6. Exhale on exertion, inhale on return motion.
 7. Turn around and repeat with the opposite leg.

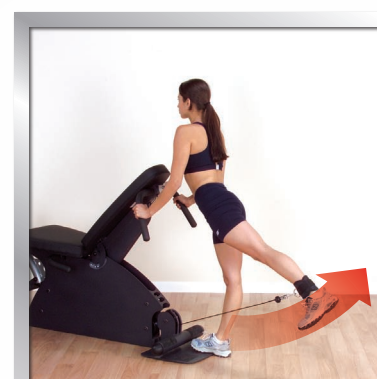

- Glute Kickback** (glutes)
1. Insert pin into weight stack at desired resistance level.
 2. Attach Ankle Strap to your left ankle and low pulley cable. Stand facing the machine on the foot platform.
 3. Keeping your legs straight and your body balanced, allow the weight to pull your left leg toward the machine. Adjust the Leg Extension / Leg Curl back pad upward and hold the handles for balance and support.
 4. Keeping both legs straight and using Gluteal strength, slowly pull your left leg backward and behind your body as far as comfortably possible.
 5. Pause for a moment, then slowly return along the same arc, to the starting position. Repeat movement.
 6. Exhale on exertion, inhale on return motion.
 7. Turn around and repeat with the opposite leg.

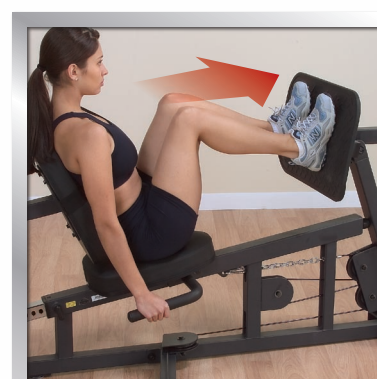

- Leg Press** (quadriceps, hamstrings, & glutes)
1. Insert pin into weight stack at desired resistance level.
 2. Sit comfortably on seat pad with your back flat against the back pad and your feet securely against the press plate.
 3. Adjust back pad so your knees are at a 90° angle.
 4. Grasp the handles at your sides for balance and stability.
 5. Using leg muscles, slowly press the foot plate until your legs are extended. **Do not lock-out your knees.**
 6. Pause for a moment, then slowly return to the starting position. Repeat movement.
 7. Exhale on exertion, inhale on return motion.

LEGS

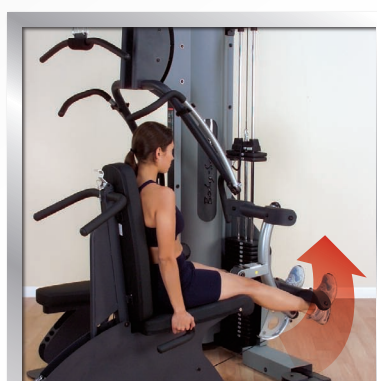

- Leg Extension** (quadriceps)
1. Insert pin into weight stack at desired resistance level.
 2. Adjust Leg Extension / Leg Curl back pad to a comfortable upright position, at approximately 75° or 85° angle.
 3. Sit comfortably on seat pad and align your knees with the pivot point.
 4. Grasp the handles at your sides for balance and stability.
 5. Using Quadriceps strength, extend your feet outward and upward until your legs are fully extended.
 6. Pause for a moment, then slowly return your feet back along the same arc, to the starting position. Repeat movement.
 7. Exhale on exertion, inhale on return motion.



- Prone Leg Curl** (hamstrings & leg biceps)
1. Insert pin into weight stack at desired resistance level.
 2. Retract the Leg Extension / Leg Curl back pad all the way down to the -10° angle.
 3. Lay face down and hook your heels under the top leg pads with your knees positioned off the edge of the seat pad.
 4. Use Hamstring strength to pull and curl your feet upward and inward, bending your knees as much as comfortably possible.
 5. Pause for a moment, then slowly return to the starting position. Repeat movement.
 6. Exhale on exertion, inhale on return motion.



- Calf Press** (gastrocnemius)
1. Insert pin into weight stack at desired resistance level.
 2. Adjust back pad to desired position.
 3. Sit comfortably on seat pad with your back flat against the back pad and the balls of your feet on the bottom portion of the press plate.
 4. Grasp the handles at your sides for balance and stability.
 5. Extend your legs and hold them in this position throughout the exercise. **Do not lock-out your knees.**
 6. Flex your toes forward as far as you comfortably can, hold that position for a moment and return to the furthest back position you comfortably can.
 7. Exhale on exertion, inhale on return motion.

KNOW YOUR GYM

Percentages indicate weight ratios. Examples: When using (both) high pulleys, 100 lbs. would equal 100 lbs. of actual weight resistance. When using leg developer, 100 lbs. would equal 150 lbs. of actual weight resistance.

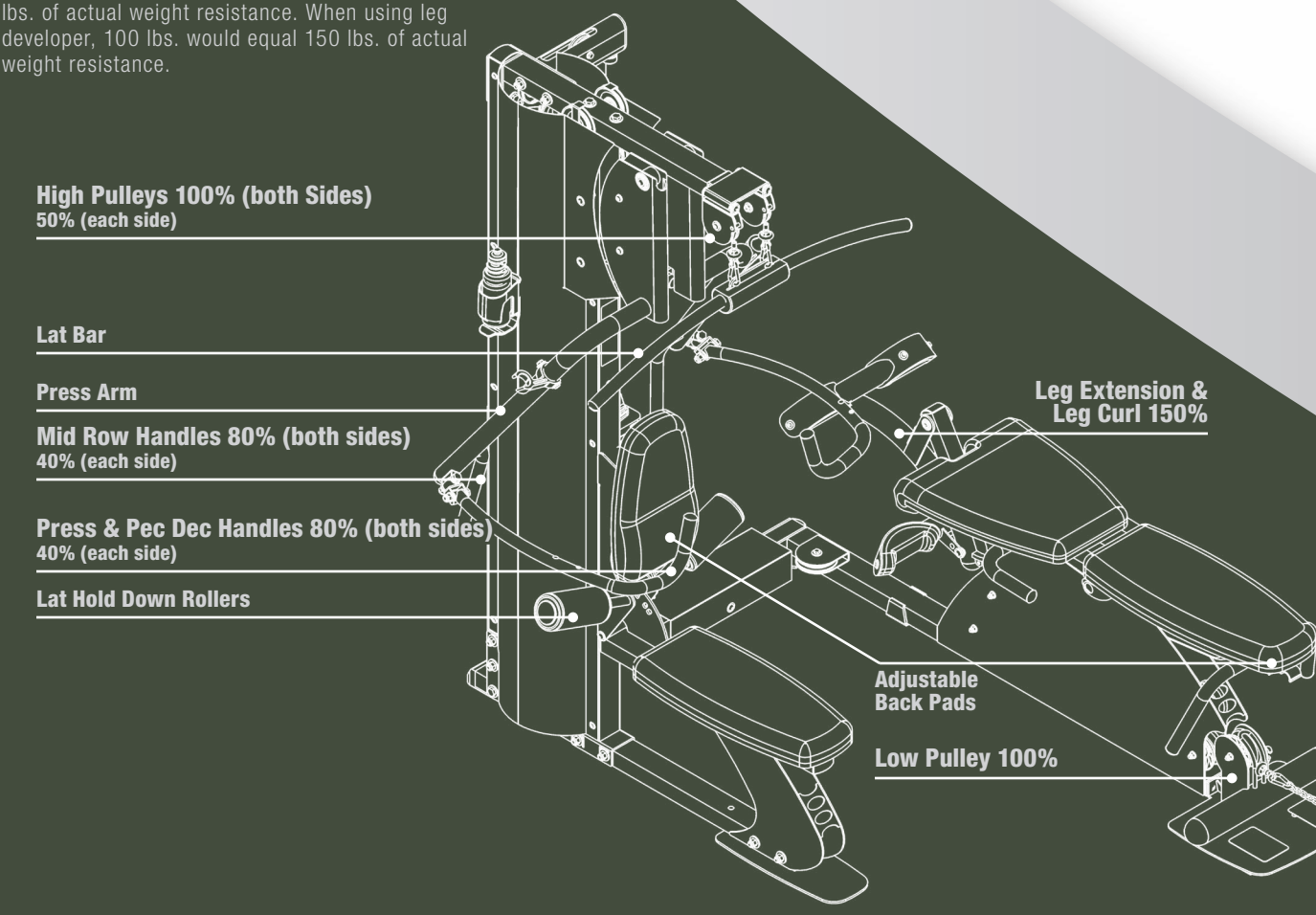

TRAINING TIPS

SAMPLE EXERCISE PROGRAMS

- Exercise your complete body every other day, up to three times a week. The one day rest enables your body to recover from the previous workout.
- Alternate your daily workouts. One day isolate the upper body exercises, and the next day perform the lower body exercises.

It is important to first establish specific and realistic goals. You should determine your long term goal and then set a series of short term goals that will help you attain your long term goal. For maximum results, follow a complete fitness program that includes proper nutrition, aerobic exercise and strength training.

SAMPLE TRAINING METHODS

- FOR MUSCULAR ENDURANCE & DEFINITION:** This training method incorporates achieving and maintaining a high cardiovascular (heart) rate and helps burn away excess fatty tissue. It also adds muscle definition and muscular endurance to your entire body. Exercises are most commonly performed for 15 to 20 repetitions and 3 to 4 sets using a light to moderate weight. The rest period between sets should be about 30 seconds. These short rest intervals will help maintain an elevated heart rate and prevent the muscles from cooling down.
- FOR STRENGTH:** This type of training is the most popular of the three and is designed specifically for increasing strength throughout the muscle and the muscle-tendon junction. This type of training is especially important for athletes. Normally, exercises are performed using moderate to heavy weight for 8 to 12 repetitions and 2 to 3 sets. The rest period between sets should be from 60 to 90 seconds. This allows a degree of muscle recovery before you hit them again.
- FOR POWER & MUSCLE MASS:** This is the method most often used by bodybuilders and is recommended only for the intermediate and advanced lifter. The weights used are heavy – this shocks the muscles and stimulates a more rapid increase in muscle size. Usually exercises are performed for 2 to 6 repetitions and 3 to 4 sets using very heavy weight. The rest period between sets should be 3 to 4 minutes. The prolonged rest periods allow ample time for recovery between sets.

A **repetition** is defined as one complete movement from the starting position, through the full range of motion, and back to the starting position. A **set** is defined as a series of continuous repetitions. Start your exercise program conservatively. Select a weight for each exercise that is easily performed for the full range of motion. Learn to feel your body's responses and change your program and training method accordingly. See Owner's Manual for more information.

SAFETY PRECAUTIONS

EXERCISE SAFETY

- Consult your physician before beginning any exercise program.
- Always warm up your muscles before starting a workout by doing at least 5 to 15 minutes of cardiovascular exercise. Then do an 8 to 12 minute stretching routine. Stretch slowly (without bouncing) and hold each stretch for at least 10 seconds. The two main purposes for stretching are injury prevention and a faster rate of recovery from exercise. Stretching should be performed in both the warm up and cool down phases of a training program.
- Use proper form. Maintain proper spinal alignment and head positioning throughout your workout. Focus on only working the muscle group intended for the exercise you are doing. If there is strain elsewhere, you may need to re-evaluate the amount of weight that is involved with the lift. Keeping proper form also includes maintaining control through the entire range of motion.
- Breathe properly. Exhale during the pressing action and inhale upon returning to the start position. Do not hold your breath during any part of an exercise.
- Be sure that all users carefully read and understand all warning, safety and maintenance labels on the machine before each use. It is absolutely necessary that you familiarize yourself and all others with the proper operation of this machine prior to use.
- Avoid the risk of injury by remaining within your limits.

EQUIPMENT SAFETY

- Make sure that all users read and understand the Owner's Manual, all warning labels and all decals on this machine prior to use. Please use all precautionary measures necessary for safety.
- Keep observers (especially children) at a safe distance away from the machine while in operation. Do not allow children to play on or around the machine at any time.
- Carefully inspect the machine before each use. Check that all nuts, bolts, pin pins and adjustment points are in place and fully tightened. Replace worn parts immediately.
- Cable inspection should be performed daily. Cables are wear items. It is your responsibility to prevent unexpected breakage. Replace any damaged or worn cable immediately. Do not allow the machine to be used until damaged or worn cables are replaced. Using a machine with a suspect cable can result in serious injury. See Owner's Manual for more information.
- Always stay clear of all weights and all moving parts when machine is in use. Obtain assistance to free any jammed parts. Never attempt to free a jammed part by yourself.
- Maintain a regular routine of preventative maintenance.
- For your own safety, do not begin any exercise program without proper instruction. See Owner's Manual for more information.

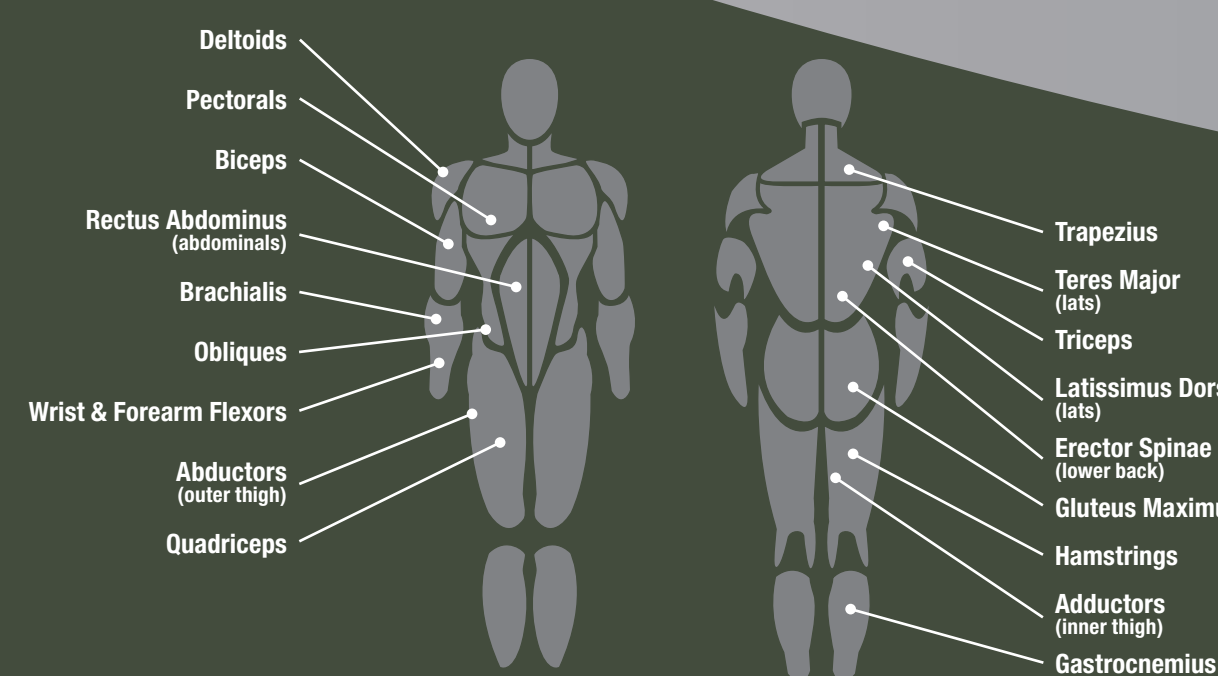

www.body-solid.com

© Copyright 2005, Body-Solid, Inc. All rights reserved. Body-Solid reserves the right to change design and specifications when we feel it will improve the product. Body-Solid machines maintain several patented and pending features and designs. All rights reserved on all design patents and utility patents. For further information, contact Body-Solid, Inc. 1900 South Des Plaines Avenue, Forest Park, IL 60130 USA • Phone: 1-708-427-3556 • Fax: 1-708-427-3556 • Web: www.body-solid.com