



EXERCISE CHART

CHEST



Converging Chest Press (pectorals)

1. Insert pin into weight stack at desired resistance level.
2. Adjust Press Arm to the Incline Press position and set back pad to the Chest Press position.
3. Adjust seat pad height so that when seated, the horizontal press handles are even with the chest (pectoral) muscles.
4. Sit comfortably on the seat pad with your back flat against the back pad.
5. Grasp horizontal press handles with your arms bent and palms facing downward.
6. Keeping your elbows out and below your shoulders, extend your arms forward at a smooth, moderate pace throughout the exercise movement.
7. Pause for a moment, then slowly return to the starting position. Repeat movement.
8. Exhale on exertion, inhale on return motion.



Converging Incline Press (pectorals)

1. Insert pin into weight stack at desired resistance level.
2. Adjust Press Arm to the Incline Press position and set back pad to the Chest Press position.
3. Adjust seat pad height so that when seated, the horizontal press handles are even with the chest (pectoral) muscles.
4. Sit comfortably on the seat pad with your back flat against the back pad.
5. Grasp horizontal press handles with your arms bent and palms facing downward.
6. Keeping your elbows out and below your shoulders, extend your arms forward at a smooth, moderate pace throughout the exercise movement.
7. Pause for a moment, then slowly return to the starting position. Repeat movement.
8. Exhale on exertion, inhale on return motion.



Pectoral Fly (pectorals)

1. Insert pin into weight stack at desired resistance level.
2. Adjust Press Arm to the Storage position.
3. Adjust seat pad height so that when seated, the pec arm handles are below your shoulder level and your arms are approximately parallel with the floor.
4. Sit comfortably on the seat pad with your back flat against the back pad.
5. Reach back and grasp the pec arm handles on each side.
6. Use Chest muscle strength to bring your arms forward and toward each other.
7. Pause for a moment, then slowly return to the starting position. Repeat movement.
8. Exhale on exertion, inhale on return motion.

SHOULDERS

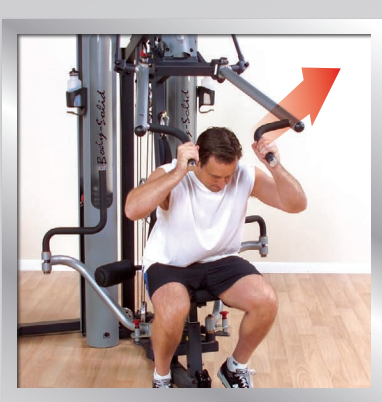

Converging Shoulder Press (deltoids)

1. Insert pin into weight stack at desired resistance level.
2. Adjust Press Arm to the Shoulder Press position and set back pad to the Shoulder Press position.
3. Adjust seat pad height so that when seated, the horizontal press handles are even with your shoulders.
4. Sit comfortably on the seat pad with your back flat against the back pad.
5. Grasp vertical press handles with your arms bent and palms facing inward.
6. Keeping your elbows out, extend your arms forward at a smooth, moderate pace throughout the exercise movement.
7. Pause for a moment, then slowly return to the starting position. Repeat movement.
8. Exhale on exertion, inhale on return motion.

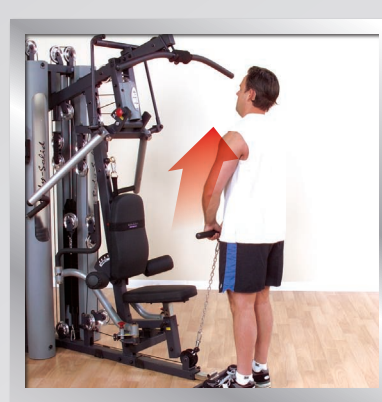

Upright Row (deltoids & trapezius)

1. Insert pin into weight stack at desired resistance level.
2. Attach Straight Bar to low pulley cable.
3. Stand erect, facing machine, with your feet approximately shoulder width apart and grasp the bar with your hands approximately 6 inches apart and your palms facing down.
4. Straighten your arms and allow the weight to pull your arms straight down.
5. Keeping your elbows above your hands at all times, slowly pull the bar upward until the back of your hands are even with your chin.
6. Pause for a moment, then slowly return to the starting position. Repeat movement.
7. Exhale on exertion, inhale on return motion.



Lateral Deltoid Raise (deltoids)

1. Insert pin into weight stack at desired resistance level.
2. Attach Stirrup Handle (optional) and chain to the low pulley cable.
3. Stand with your right side toward the machine.
4. Securely grasp the handle with your left hand and your palm facing down.
5. Use Shoulder muscle strength to slowly raise the handle upward and outward in a semicircular arc until it is in a position even with your shoulder level.
6. Pause for a moment, then slowly return to the starting position. Repeat movement.
7. Exhale on exertion, inhale on return motion.
8. Change hands, turn around, and repeat with the opposite arm.

BACK

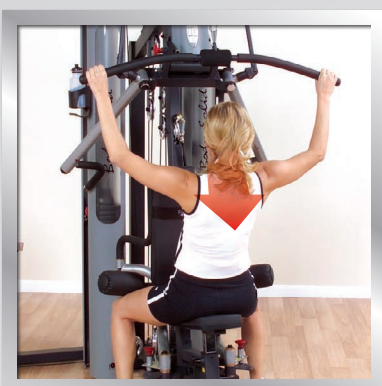

Lat Pull Down (latissimus dorsi)

1. Insert pin into weight stack at desired resistance level.
2. Adjust Press Arm to the Storage position and attach Lat Bar to the high pulley cable.
3. Adjust seat pad so your legs will lock-down comfortably under rollers. Sit on seat pad facing into machine.
4. Grasp Lat Bar 3 to 6 inches wider than your shoulders on each side.
5. Keeping your elbows back during movement, slowly pull the Lat Bar down until it lightly touches the upper part of your chest. Never pull down toward your head or neck.
6. Pause for a moment, then slowly return to the starting position. Repeat movement.
7. Exhale on exertion, inhale on return motion.



Seated Row (latissimus dorsi)

1. Insert pin into weight stack at desired resistance level.
2. Attach Straight Bar to low pulley cable and move foot back pad to Chest Press position.
3. Sit on the floor with your knees slightly bent and your feet placed firmly against the foot brace.
4. Grasp the Bar in both hands. Straighten your arms and lean towards the pulley to completely stretch your lats.
5. Pull the Bar towards your midsection, being sure to keep your elbows close to your sides. Continue to pull the Bar until it touches your midsection.
6. Pause for a moment, then slowly return to the starting position. Repeat movement.
7. Exhale on exertion, inhale on return motion.

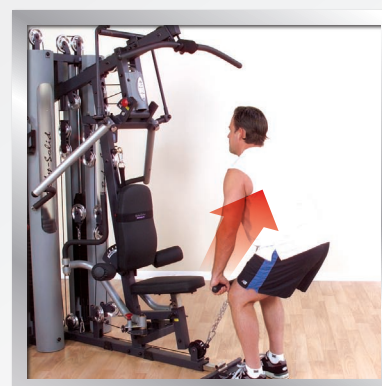

Bent Over Row (lower back)

1. Insert pin into weight stack at desired resistance level.
2. Attach Straight Bar to low pulley cable.
3. Set your feet shoulder width apart, grasp the Straight Bar with both hands, palms facing away down.
4. Straighten your arms and bend your legs slightly. Bend at the waist until your torso is at a 45° angle.
5. Keeping your elbows out, pull the Bar upward and slightly back until it touches your lower midsection.
6. Pause for a moment, then slowly return to the starting position. Repeat movement.
7. Exhale on exertion, inhale on return motion.

ARMS

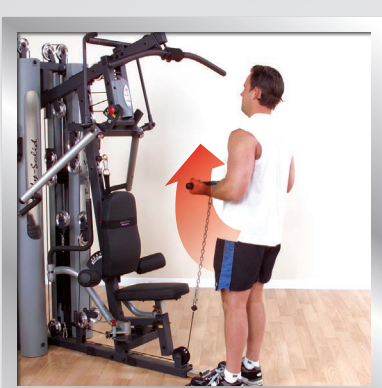

Biceps Curl (biceps)

1. Insert pin into weight stack at desired resistance level.
2. Attach Straight Bar to low pulley cable.
3. Facing the machine, take an underhand grasp on the bar. Stand erect with your feet on the foot plate. Your arms should be down at your sides with the bar resting on your thighs.
4. Keeping your upper arms locked against the sides of your torso, use Biceps strength to curl the bar upward and forward in a semicircular arc to a position beneath your chin.
5. Pause for a moment, then slowly return the bar back along the same arc, to the starting position. Repeat movement.
6. Exhale on exertion, inhale on return motion.

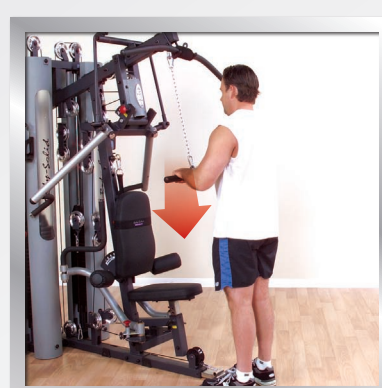

Triceps Press Down (triceps)

1. Insert pin into weight stack at desired resistance level and adjust Press Arm to Storage position.
2. Attach Straight Bar with chain to high pulley cable.
3. Facing the machine, stand erect with your feet set at approximately shoulder width. Grip the bar securely with your palms facing forward.
4. Pull the bar down and lock your upper arms against the sides of your torso where they must remain throughout the exercise movement. Lean slightly forward at the waist.
5. Moving only your forearms, use Triceps strength to push the bar downward in a semicircular arc to a position below your waist.
6. Pause for a moment, then slowly return the bar back along the same arc, to the starting position. Repeat movement.
7. Exhale on exertion, inhale on return motion.

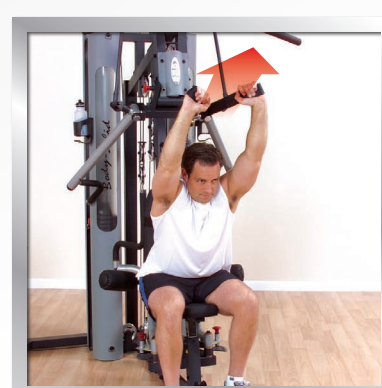

Triceps Extension (triceps)

1. Insert pin into weight stack at desired resistance level and adjust Press Arm to Storage position.
2. Attach Triceps / Ab Strap to mid pulley cable. Adjust back pad to Chest Press position.
3. Sit on seat pad, facing away from the machine.
4. Bend at the waist so that your torso is at an approximate 45° angle. Keep your hands behind your head and your arms bent with your elbows facing forward.
5. Keeping your upper arms motionless, use Triceps strength to move the strap forward until your arms are extended.
6. Pause for a moment, then slowly return the strap back along the same arc, to the starting position. Repeat movement.
7. Exhale on exertion, inhale on return motion.

ABS

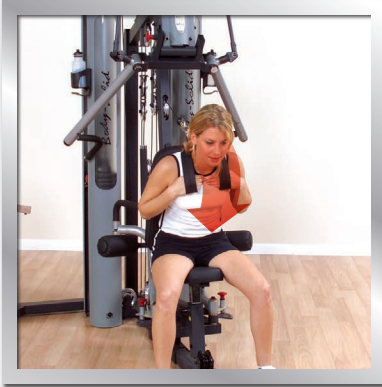

Resistance Ab Crunch (abdominals)

1. Insert pin into weight stack at desired resistance level and adjust Press Arm to Storage position.
2. Attach Triceps / Ab Strap to mid pulley cable and adjust back pad to Chest Press position.
3. Sit on seat pad with your back resting against back pad. Grasp the strap and place it securely over your shoulders, keeping your hands planted firmly on your upper chest throughout the exercise movement.
4. Using Abdominal muscle strength, slowly bend forward at the waist as far as comfortably possible.
5. Pause for a moment, then slowly return back to the starting position. Repeat movement.
6. Exhale on exertion, inhale on return motion.

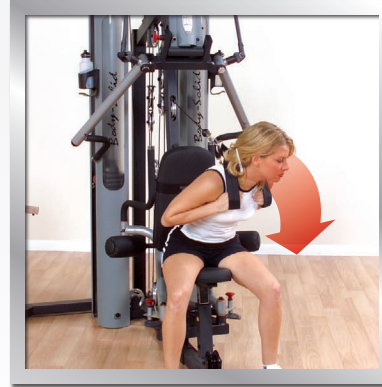

Oblique Crunch (obliques & abdominals)

1. Insert pin into weight stack at desired resistance level and adjust Press Arm to Storage position.
2. Attach Triceps / Ab Strap to mid pulley cable and adjust back pad to Chest Press position.
3. Sit on seat pad with your back resting against back pad. Grasp the strap and place it securely over your shoulders, keeping your hands planted firmly on your upper chest throughout the exercise movement.
4. While holding the strap firmly over your shoulders, simultaneously bend forward and rotate your upper body slowly to the left as far as comfortably possible while keeping your legs and hips stationary.
5. Pause for a moment, then slowly return to the starting position. Repeat the movements from the left to the right and then repeat the movements.
6. Exhale on exertion, inhale on return motion.
7. Exhale on exertion, inhale on return motion.

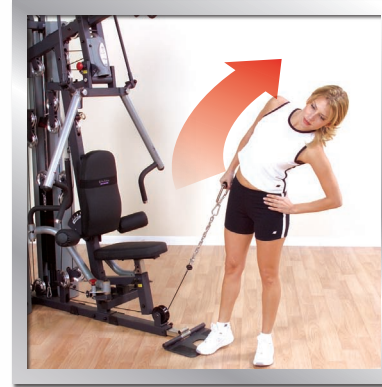

Oblique Bend (obliques)

1. Insert pin into weight stack at desired resistance level.
2. Attach Stirrup Handle (optional) and chain to low pulley cable.
3. Take an overhand grasp of the handle with your right hand and stand 1 to 2 feet away from the machine with your right side toward the machine.
4. Keeping your arm, legs, and hips straight, bend your torso away from the machine.
5. Pause for a moment, then slowly return your torso back along the same arc, to the starting position. Repeat movement.
6. Exhale on exertion, inhale on return motion.
7. Turn around and repeat with the opposite hand.

HIPS/THIGHS



Leg Abduction (hip & outer thigh)

1. Insert pin into weight stack at desired resistance level.
2. Attach Ankle Strap to your left ankle and low pulley cable. Stand 1 to 2 feet away from the pulley with your right side toward the machine. Grasp press arm for stability.
3. Keeping your legs straight and body balanced, allow the weight to pull your left leg across your body and toward the machine.
4. Using Outer Thigh strength, slowly pull your left leg across and away from your body as far as comfortably possible.
5. Pause for a moment, then slowly return along the same arc, to the starting position. Repeat movement.
6. Exhale on exertion, inhale on return motion.
7. Turn around and repeat with the opposite leg.

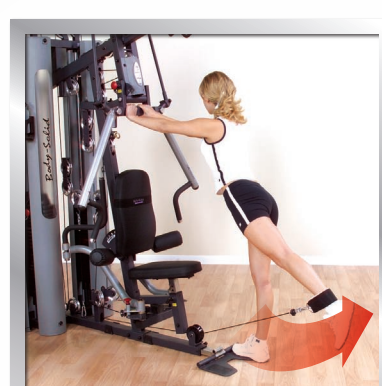

Glute Kickback (glutes)

1. Insert pin into weight stack at desired resistance level.
2. Attach Ankle Strap to your left ankle and low pulley cable. Stand facing the machine on the foot platform.
3. Keeping your legs straight and body balanced, allow the weight to pull your left leg toward the machine. Hold onto the top for balance and support.
4. Keeping both legs straight and using Gluteal strength, slowly pull your left leg backward and behind your body as far as comfortably possible.
5. Pause for a moment, then slowly return along the same arc, to the starting position. Repeat movement.
6. Exhale on exertion, inhale on return motion.
7. Repeat with the opposite leg.

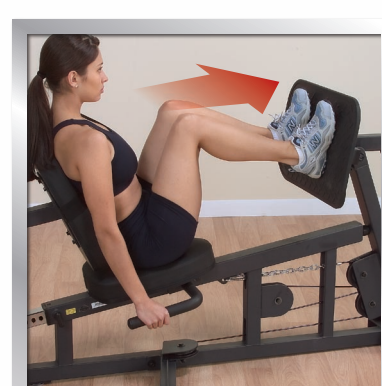

Leg Press (quadriceps, hamstrings, & glutes)

1. Insert pin into weight stack at desired resistance level.
2. Sit comfortably on seat pad with your back flat against the back pad and your feet secured against the press plate.
3. Adjust back pad so your knees are at a 90° angle.
4. Grasp the handles at your sides for balance and stability.
5. Using leg muscles, slowly press the foot plate until your legs are extended. Do not lock-out your knees.
6. Pause for a moment, then slowly return to the starting position. Repeat movement.
7. Exhale on exertion, inhale on return motion.

Leg Press Station Optional #6LP

LEGS



Leg Extension (quadriceps)

1. Insert pin into weight stack at desired resistance level.
2. Sit comfortably on seat pad. Adjust back pad so that your knee joints line up with the pivot point.
3. Hook your feet under the lower leg pad and adjust that pad to a comfortable, starting Leg Extension position.
4. Using Quadriceps strength, extend your feet outward and upward until your legs are fully extended.
5. Pause for a moment, then slowly return your feet back along the same arc, to the starting position. Repeat movement.
6. Exhale on exertion, inhale on return motion.



Seated Leg Curl (hamstrings & leg biceps)

1. Insert pin into weight stack at desired resistance level.
2. Sit comfortably on seat pad. Adjust back pad so that your knee joints line up with the pivot point.
3. Place your heels on top of the lower leg pad and adjust that pad to a comfortable, starting Leg Curl position.
4. Adjust the top leg pad to lock your legs as comfortably possible.
5. Use Hamstring strength to curl your feet inward and downward, bending your knees as much as comfortably possible.
6. Pause for a moment, then slowly return to the starting position. Repeat movement.
7. Exhale on exertion, inhale on return motion.

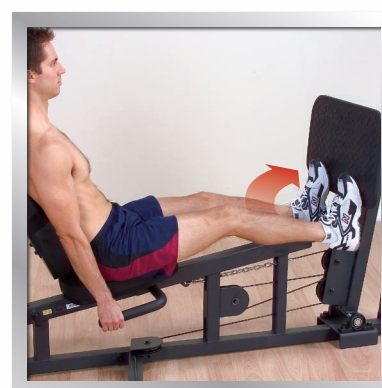

Calf Press (gastrocnemius)

1. Insert pin into weight stack at desired resistance level.
2. Adjust back pad to desired position.
3. Sit comfortably on seat pad with your back flat against the back pad and the balls of your feet on the bottom portion of the press plate.
4. Grasp the handles at your sides for balance and stability.
5. Extend your legs and hold them in this position throughout the exercise. Do not lock-out your knees.
6. Flex your toes forward as far as you comfortably can, hold that position for a moment and return to the furthest back position you comfortably can.
7. Exhale on exertion, inhale on return motion.

Leg Press Station Optional #6LP

KNOW YOUR GYM

Percentages indicate weight ratios. Examples: When using high pulley, 100 lbs. would equal 90 lbs. of actual weight resistance. When using leg developer, 100 lbs. would equal 200 lbs. of actual weight resistance.

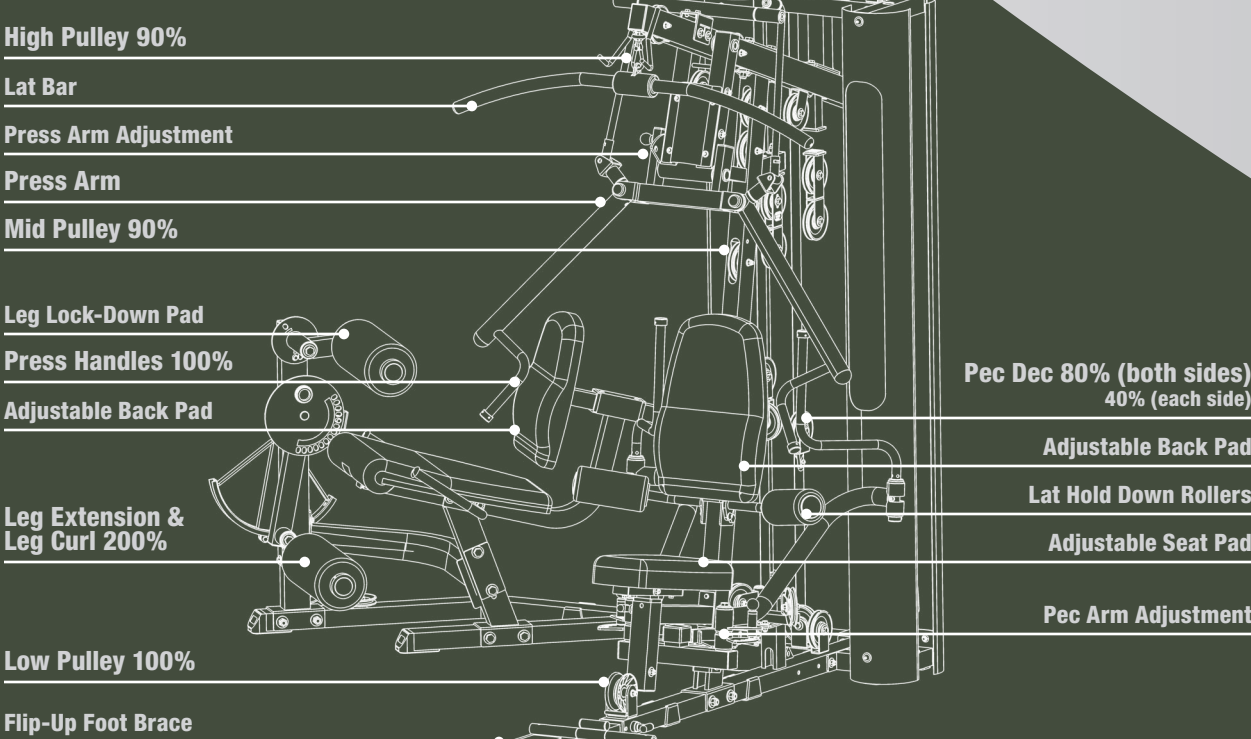

TRAINING TIPS

SAMPLE EXERCISE PROGRAMS

- A. Exercise your complete body every other day, up to three times a week. The one day rest enables your body to recover from the previous workout.
- B. Alternate your daily workouts. One day isolate the upper body exercises, and the next day perform the lower body exercises.

It is important to first establish specific and realistic goals. You should determine your long term goal and then set a series of short term goals that will help you attain your long term goal. For maximum results, follow a complete fitness program that includes proper nutrition, aerobic exercise and strength training.

SAMPLE TRAINING METHODS

- FOR MUSCULAR ENDURANCE & DEFINITION:** This training method incorporates achieving and maintaining a high cardiovascular (heart) rate and helps burn away excess fatty tissue. It also aids muscle definition and muscular endurance to your entire body. Exercises are most commonly performed for 15 to 20 repetitions and 3 to 4 sets using a light to moderate weight. The rest period between sets should be about 30 seconds. These short rest intervals will help maintain an elevated heart rate and prevent the muscles from cooling down.
- FOR STRENGTH:** This type of training is the most popular of the three and is designed specifically for increasing strength throughout the muscle and the muscle-tendon junction. This type of training is especially important for athletes. Normally, exercises are performed using moderate to heavy weight for 8 to 12 repetitions and 2 to 3 sets. The rest period between sets should be from 60 to 90 seconds. This allows a degree of muscle recovery before you hit them again.
- FOR POWER & MUSCLE MASS:** This is the method most often used by bodybuilders and is recommended only for the intermediate and advanced lifter. The weights used are heavy – this shocks the muscles and stimulates a more rapid increase in muscle size. Usually exercises are performed for 2 to 6 repetitions and 3 to 4 sets using very heavy weight. The rest period between sets should be 3 to 4 minutes. The prolonged rest periods allow ample time for recovery between sets.

A **repetition** is defined as one complete movement from the starting position, through the full range of motion, and back to the starting position. A **set** is defined as a series of continuous repetitions. Start your exercise program conservatively. Select a weight for each exercise that is easily performed for the full range of motion. Learn to feel your body's responses and change your program and training method accordingly. See **Owner's Manual** for more information.

SAFETY PRECAUTIONS

EXERCISE SAFETY

1. Consult your physician before beginning any exercise program.
2. Always warm up your muscles before starting a workout by doing at least 5 to 15 minutes of cardiovascular exercise. Then do an 8 to 12 minute stretching routine. Stretch slowly (without bouncing) and hold each stretch for at least 10 seconds. The two main purposes for stretching are injury prevention and a faster rate of recovery from exercise. Stretching should be performed in both the warm up and cool down phases of a training program.
3. Use proper form. Maintain proper spinal alignment and head positioning throughout your workout. Focus on only working the muscle group intended for the exercise you are doing. If there is strain elsewhere, you may need to re-evaluate the amount of weight that is involved with the lift. Keeping proper form also includes maintaining control through the entire range of motion.
4. Breathe properly. Exhale during the pressing action and inhale upon returning to the start position. Do not hold your breath during any part of an exercise.
5. Be sure that all users carefully read and understand all warning, safety and maintenance labels on the machine before each use. It is absolutely necessary that you familiarize yourself and all others with the proper operation of this machine prior to use.
6. Avoid the risk of injury by remaining within your limits.

EQUIPMENT SAFETY

1. Make sure that all users read and understand the Owner's Manual, all warning labels and all decals on this machine prior to use. Please use all precautionary measures necessary for safety.
2. Keep observers (especially children) at a safe distance away from the machine while in operation. Do not allow children to play on or around the machine at any time.
3. Carefully inspect the machine before each use. Check that all nuts, bolts, pin pins and adjustment points are in place and fully tightened. Replace worn parts immediately.
4. Cable inspection should be performed daily. Cables are wear items. It is your responsibility to prevent unexpected breakage. Replace any damaged or worn cable immediately. Do not allow the machine to be used until damaged or worn cables are replaced. Using a machine with a suspect cable can result in serious injury. See Owner's Manual for more information.
5. Always stay clear of all weights and all moving parts when machine is in use. Obtain assistance to free any jammed parts. Never attempt to free a jammed part by yourself.
6. Maintain a regular routine of preventative maintenance.
7. For your own safety, do not begin any exercise program without proper instruction. See **Owner's Manual** for more information.

