



Steelflex

CARDIO
CARDIO

BIKE / ELLIPTICAL / STEPPER

USER MANUAL V.6

TABLE OF CONTENTS

SAFETY INSTRUCTIONS.....	2-3
MOVING	4
SEAT ADJUSTMENT	5
LEVELER ADJUSTMENT	6
OPERATING INSTRUCTIONS FOR PST10	7-18
OPERATING INSTRUCTIONS FOR PBI0/PRI0/PESG	19-27
OPERATING INSTRUCTIONS FOR PEI0.....	28-43
MAINTENANCE.....	44
WARRANTY CONDITIONS.....	45-46

SAFETY INSTRUCTIONS

IMPORTANT SAFETY INSTRUCTIONS SAVE THESE INSTRUCTIONS

When using an electrical product, follow basic precautions, including the following:

WARNING!

To reduce the risk of burns, fire, electrical shock or injury to persons:

- Use this exercise product for its intended use as described in this User Manual. Do not use attachments not recommended by the manufacturer.
- Never drop or insert any object into any opening.
- Do not remove the Bike / Elliptical / Stepper side covers. Only an authorized **STEELFLEX** retailer should perform Service.
- Never operate this product if it has a damaged cord or plug, if it is not working properly, if it has been damaged, or immersed in water. Have equipment examined as required by an authorized **STEELFLEX** service provider.
- Do not use outdoors.
- When the **STEELFLEX** product is in use, young children and pets should be kept at least 10 feet away.
- Keep children off your **STEELFLEX** product at all times.

SAFETY INSTRUCTIONS

SAFETY INSTRUCTIONS:

CAUTION!

- If you experience chest pains, nausea, dizziness or shortness of breath, stop exercising immediately and consult your physician before continuing.
- Do not wear clothing that might catch on any part of the **STEELFLEX** product.
- Read this User Manual before operating this product.

MOVING

Each **STEELFLEX** product equips with a pair of transport wheels built into the front leg. Follow instructions below to move your **STEELFLEX** product.



- To move PR10, firmly grasp rear handlebar, carefully lift and roll on transport wheels.



- To move PB10, firmly grasp the handlebars, carefully tip toward you and roll on the transport wheels.



- To move PESG/PE10, firmly grasp assembled rear foot, carefully lift and roll on transport wheels.



- To move PST10, firmly grasp bottom areas of handlebars, carefully lift and roll on the transport wheels.

Caution:

The product is heavy. Take caution and use additional help if necessary.

SEAT ADJUSTMENT

The seat is at the proper position when your knee is slightly bent when the pedal is in the furthest position.

Item : PB10 and PR10

To adjust PB10 and PR10 seat position, all you need to do is pull the adjusted handle up and move the seat to the position you feel comfortable. When the seat position is set, let your hand off the adjusted handle.

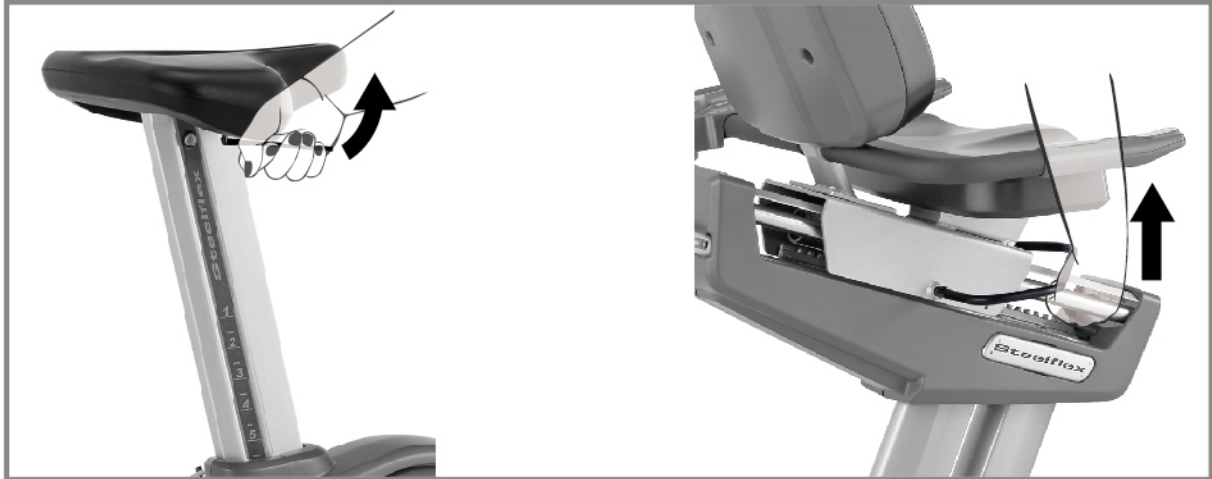

LEVELER ADJUSTMENT

Before exercising, ensure machine is level. If not level, adjust levelers.

Item : for PST10 , PB10 and PR10

	Two are in the front and two are in the rear.
	Adjust to level and stabilize unit.
	Tighten upper disk to lock position.

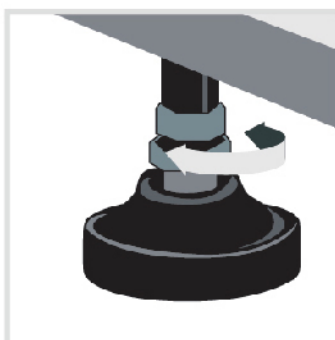

Item : for PESG/PE10 series

After finding a location that is suitable for the elliptical, you can adjust four levelers which allow you to adjust until it is properly seated on the floor.

DO NOT adjust levelers while the elliptical is used.

OPERATING INSTRUCTIONS

Display Introduction

The display of your PST 10 is used to operate the unit. It includes information window and button location.



INFORMATION WINDOW



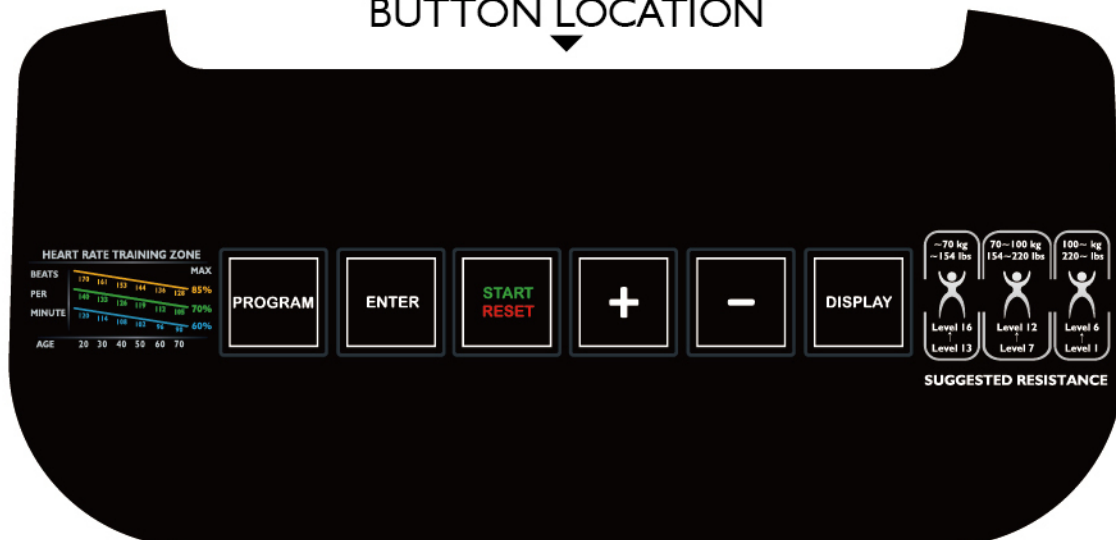







BUTTON LOCATION



OPERATING INSTRUCTIONS

Information window







The information window provides two different types of information: programs directions and user workout data. Program direction will be explained with programs later. User workout data includes:

User workout data	Description
TIME 	Indicates time in minutes and seconds (mm:ss).
STEP 	Indicates step counts during workout.
 LEVEL	Indicates current resistance of user's workout.
 PRO.	Indicates workout program user chooses.
 H.R.C	Indicates user's heart rate during workout.
 CAL.	Indicates accumulated calories burned during workout.
 WATT	Indicates power consumption of workout.
 DIST.	Indicates exercising distance of your workout.
 SPM	Indicates user's workout steps per minute.
 SPEED	Indicates speed of workout.

OPERATING INSTRUCTIONS

Button location







Description of each button is listed below.

	Choose workout program.
	Enter data.
	Under START condition, press another time will be RESET. Under RESET condition, press another time will be START.
	Increasing setting values.
	Decreasing setting values.
	Workout data display changes.

OPERATING INSTRUCTIONS

Engineer Mode

Steelflex stepper is designed for different users. Base on your location and user characteristics; please follow the instructions to set up the machine before starting using.





step 1	Press and hold  and  together for 3 seconds. Software version will be shown for 3 seconds, then enter metric/imperial setting.
step 2	Press  or  to set metric/imperial, then press  .
step 3	“TOTAL TIME” which means accumulated total workout time of the machine will be shown. Press  to leave engineer mode.

OPERATING INSTRUCTIONS

Programs

There are 9 different exercising programs which includes manual, cardio, fat burn, interval, goal-time, goal-distance, goal-calories, goal-step and HRC. Operations are explained as following.









Manual(P1)

step 1	Set weight by pressing  and  , then press  . Default value is 70 KGS/150LBS.
step 2	Choose P1 by pressing  , then press  to start your workout.

1. Time, distance, calories and step will be counted up from 0.

OPERATING INSTRUCTIONS

Cardio(P2)/Fat Burn(P3)/Interval(P4)









step 1	Set weight by pressing  and  , then press  . Default value is 70 KGS/150LBS.
step 2	Choose P2/P3/P4 by pressing  , then press  .
step 3	Press  and  to set workout time.
step 4	Press  to start your workout.

I. Time will be count down from default value or setting value.

Distance, calories and step will be counted from 0.

OPERATING INSTRUCTIONS









Goal-time(P5)

step 1	Set weight by pressing  and  , then press  . Default value is 70 KGS/150LBS.
step 2	Choose P5 by pressing  , then press  .
step 3	Press  or  to set workout time. Default value is 30 minutes. Then press  .
step 4	Press  to start your workout.

- I. Time will be count down from default value or setting value.
Distance, calories and step will be counted up from 0.

OPERATING INSTRUCTIONS









Goal-distance(P6)

step 1	Set weight by pressing  and  , then press  . Default value is 70 KGS/150LBS.
step 2	Choose P6 by pressing  , then press  .
step 3	Press  or  to set distance. Default value is 0.5. Then press  .
step 4	Press  to start your workout.

- 1. Distance will be count down from default value or setting value.
Time, calories and step will be counted up from 0.

OPERATING INSTRUCTIONS

Goal-calories(P7)









step 1	Set weight by pressing  and  , then press  . Default value is 70 KGS/150LBS.
step 2	Choose P7 by pressing  , then press  .
step 3	Press  or  to set calories. Default value is 200. Then press  .
step 4	Press  to start your workout.

I. Calories will be count down from default value or setting value.

Time, distance and step will be counted up from 0.

OPERATING INSTRUCTIONS

Goal-step(P8)











step 1	Set weight by pressing  and  , then press  . Default value is 70 KGS/150LBS.
step 2	Choose P8 by pressing  , then press  .
step 3	Press  or  to set distance. Default value is 1000. Then press  .
step 4	Press  to start your workout.

1.Step will be count down from default value or setting value.

Time, distance and calories will be counted up from 0.

OPERATING INSTRUCTIONS

HRC(P9)

step 1	Set weight by pressing  and  , then press  . Default value is 70 KGS/150LBS.
step 2	Choose P9 by pressing  , then press  .
step 3	Set age by pressing  and  . Default value is 30. Then press  .
step 4	Set max. pulse % by pressing  and  . Default value is 70%. Then press  . If heart rate is more than 20 bpm below target, level will increase 2 every 30 seconds. If heart rate is more than 10 bpm below target, level will increase 1 every 30 seconds. If heart rate is more than 20 bpm above target, level will decrease 2 every 30 seconds.

OPERATING INSTRUCTIONS

step 4	If heart rate is more than 10 bpm above target, level will decrease 1 every 30 seconds. If heart rate can not be detected, PULSE will be shown on the display every 0.5 second, and level doesn't change.
step 5	Press  to start your workout.

1. Time, distance, calories and step will be counted up from 0.

Note

1. During workout, if user wants to reset, please press and hold



for 3 seconds.

2. If no signal is detected in 30 seconds, it will enter sleep mode.

Once it wakes up, it will back to weight setting.

3. When END is shown on the display, user can press  to back to start condition or it will go back to program setting condition after 3 minutes.

DISPLAY INSTRUCTION

The display of your PB10, PR10 or PESG is used to operate the unit. It includes information window and button location.

INFORMATION WINDOW

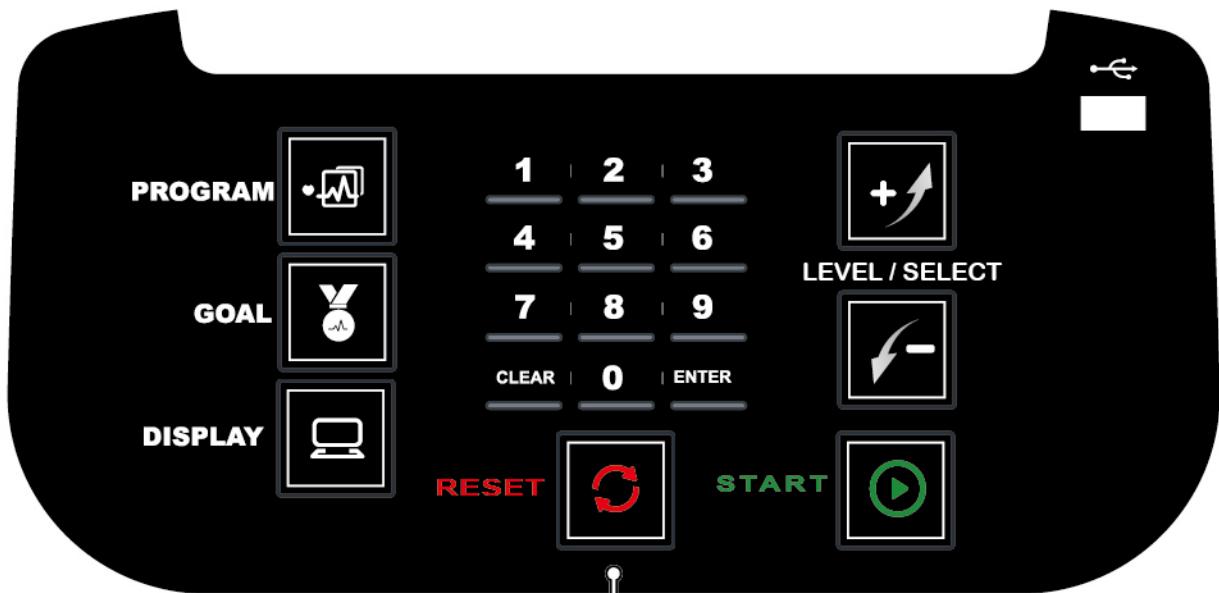
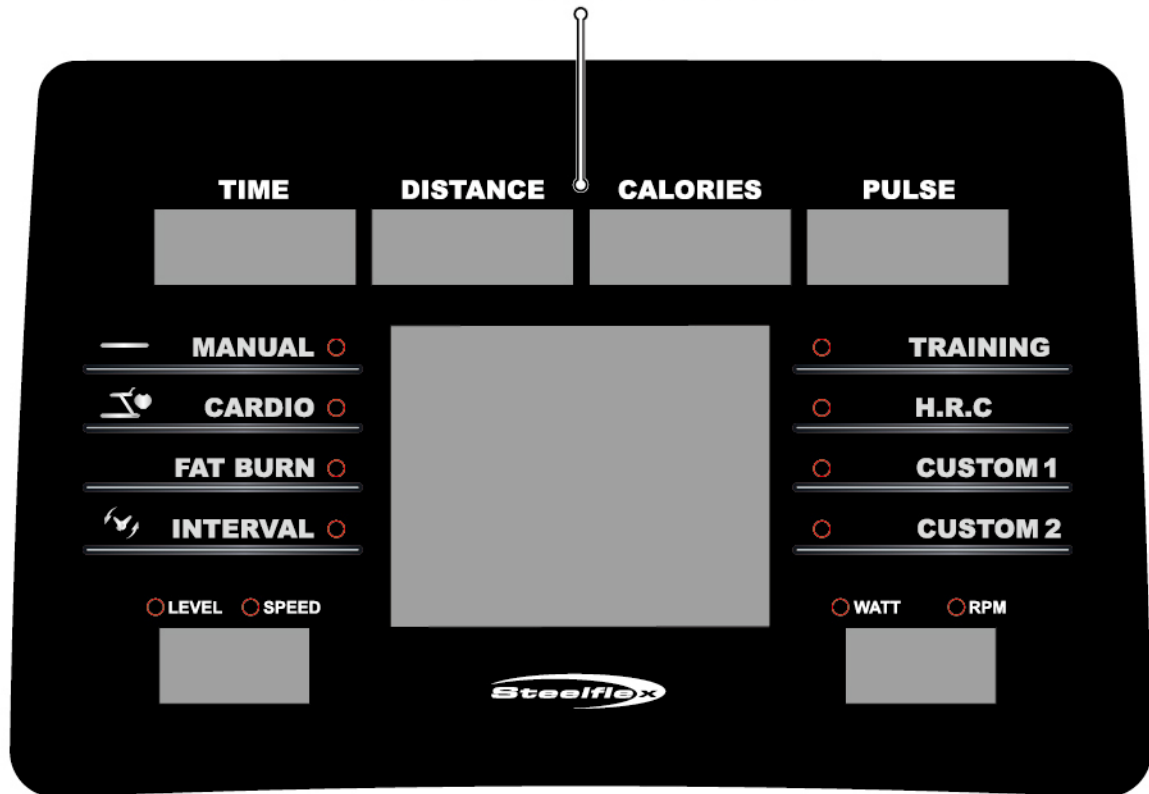

BUTTON LOCATION

INFORMATION WINDOW

Information window









The information window provides two different types of information: program directions and user information data. Program directions will be explained with programs later. User information data includes:

User information	Description
TIME	Indicates time in minutes and seconds(mm:ss).
DISTANCE	Indicates exercising distance during your workout.
CALORIES	Indicated accumulated calories burned during your workout.
PULSE	Indicates heart rate beats per minute during your workout. (Only displayed if you are using contact heart rate bar or chest belt.)
LEVEL	Indicates current resistance of your workout.
SPEED	Indicates speed of your workout. (Either miles or kilometers)
WATT	Indicates power consumption of your workout.
RPM	Indicates pedal rotations : per minute.

BUTTON LOCATION

BUTTON LOCATION



Description of each button is listed below.

PROGRAM 	Choose workout program.
GOAL 	Set workout goal which can be time, distance or calories.
DISPLAY 	Workout data display changes.
START 	Start your workout.
RESET 	Reset data.
	Setting number increases. Press and hold this button to increase quickly.
	Setting number decreases. Press and hold this button to decrease quickly.
ENTER 	Enter data.
CLEAR 	Clear numerical settings when setting time, distance or calories.

OPERATION INSTRUCTION

Engineer Mode

Steelflex products are designed for different users. Base on your location and user characteristic; please follow the instructions to set up the machines before starting using.

step 1	Press and hold RESET  and ENTER together for a while. Software version will be shown on WATT/RPM window.
step 2	KG/LBS will be shown on the Matrix window. It can be adjusted by  or  , then press ENTER .
step 3	TOTAL TIME(accumulated workout hours) is shown on PULSE window, then press ENTER to leave engineer mode.

OPERATION INSTRUCTION



Programs

There are 8 different exercise programs which include manual, cardio, fat burn, interval, training, H.R.C., custom 1 and custom 2. Operations are explained as following.

Manual









step 1	Press  or  to set weight, then press  .
step 2	Press PROGRAM  to choose MANUAL.
step 3	Press GOAL  to set workout goal (time, distance or calories). Press  or  to adjust value.
step 4	Press START  to start your workout.

Note:

1. During workout, you can adjust resistance by pressing  or . When resistance level is adjusted, from present workout segment to final workout segment, resistance levels will be changed together.

OPERATION INSTRUCTION

CARDIO/FAT BURN/INTERVAL/TRAINING











step 1	Press  or  to set weight, then press  .
step 2	Press PROGRAM  to choose CARDIO/ FAT BURN/ INTERVAL.
step 3	Press GOAL  to set workout goal (time, distance or calories). Press  or  to adjust setting value. Default value of time is 30:00. Default value of distance is 5.0. Default value of calories is 150.
step 4	Press START  to start your workout.

Note:



I. During workout, you can press  or  to change profile.

OPERATION INSTRUCTION



H.R.C.

step 1	Press  or  to set weight, then press  .
step 2	Press PROGRAM  to choose H.R.C..
step 3	Press GOAL  to set workout goal (time, distance or calories). Press  or  to adjust setting value, then press  . Default value of time is 30:00. Default value of distance is 5.0. Default value of calories is 150.
step 4	Press  or  to set age, then press  . Default value is 30.

OPERATION INSTRUCTION











step 5	<p>Press  or  to set pulse %. Default value is 70%.</p> <p>If heart rate is more than 20 bpm below target, level will increase 2 every 30 seconds.</p> <p>If heart rate is more than 10 bpm below target, level will increase 1 every 30 seconds.</p> <p>If heart rate is more than 20 bpm above target, level will decrease 2 every 30 seconds.</p> <p>If heart rate is more than 10 bpm above target, level will decrease 1 every 30 seconds.</p> <p>If heart rate can not be detected, PULSE will be showed on the display every 0.5 second, and level doesn't change.</p> <p>If no signal is detected in 60 seconds, level decreases 4 every 30 seconds.</p>
step 6	Press START  to start your workout.

Note:



1. During workout, you can adjust resistance by pressing  or . When resistance level is adjusted, from present workout segment to final workout segment, resistance levels will be changed together.

OPERATION INSTRUCTION

CUSTOM 1/CUSTOM 2

step 1	Press  or  to set weight, then press  .
step 2	Press PROGRAM  to choose CUSTOM 1 or CUSTOM 2, then press  .
step 3	Press GOAL  to set workout goal (time, distance or calories) , then press  .
step 4	Press numeric buttons to set each segment's resistance level. Press  or  to set last or next segment resistance level.
step 5	Press START  to save your settings and start your workout.

Note:

1. During workout, you can adjust resistance level by pressing  or  . Only the segment you workout can be adjusted.

GROUNDING INSTRUCTIONS

This product must be grounded. If it should malfunction or breakdown, grounding provides a path of least resistance for electric current to reduce the risk of electric shock. This product is equipped with a cord having an equipment-grounding conductor and grounding plug. The plug must be plugged into an appropriate outlet that is properly installed and grounded in accordance with all local codes and ordinances.

DANGER-Improper connection of the equipment-grounding conductor can result in a risk of electric shock. Check with a qualified electrician or serviceman if you are in doubt as to whether the product is properly grounded. Do not modify the plug provided with the product- if it will not fit the outlet, have a proper outlet installed by a qualified electrician.

Make sure that the product is connected to an outlet having the same configuration as the plug. No adapter should be used with this product.

- The appliance must be positioned so that the plug is accessible.
- If the power cord is damaged; it must be replaced by the manufacturer or its service agent or a similarly qualified person in order to avoid a safety hazard.

SAFETY INSTRUCTIONS

IMPORTANT SAFETY INSTRUCTIONS

When using an electrical appliance, basic precautions should always be followed, including the following:

Read all instructions before using the PE10.

DANGER - To reduce the risk of electric shock:

Always unplug this appliance from the electrical outlet immediately after using and before cleaning.

WARNING - To reduce the risk of burns, fire, electric shock, or injury to persons:

1. An appliance should never be left unattended when plugged in. Unplug from outlet when not in use, and before putting on or taking off parts.
2. Close supervision is necessary when this appliance is used by, on, or near children, invalids, or disabled persons.
3. Use this appliance only for its intended use as described in this manual. Do not use attachments not recommended by the manufacture.
4. Never operate this appliance if it has a damaged cord or plug, if it is not working properly, if it has been dropped or damaged, or dropped into water. Call service for examination and repair.
5. Keep the cord away from heated surfaces.
6. Never drop or insert any object into any opening.

7. Do not use outdoors.
8. To disconnect, turn all controls to the off position, then remove plug from outlet.
9. Connect this appliance to a properly grounded outlet only.
See Grounding Instructions.
10. Never Tie off Safety Cord, as this will bypass the SAFE use, could cause a choking hazard for children, and / or present other unsafe use of product. Remove and store safety cord and plug after use. Keep out of reach of children.
11. The appliance is not to be used by children or persons with reduced physical, sensory or mental capabilities, or lack of experience and knowledge, unless they have been given supervision or instruction.
12. Children being supervised not to play with the appliance.
13. For commercial use.
14. CAUTION:
To Reduce The Risk Of Injury From Moving Parts - Unplug Before Servicing.
15. WARNING:
To Reduce the Risk of Electric Shock – Unplug Before Cleaning or Servicing.

SAVE THESE INSTRUCTIONS

Figure Grounding methods

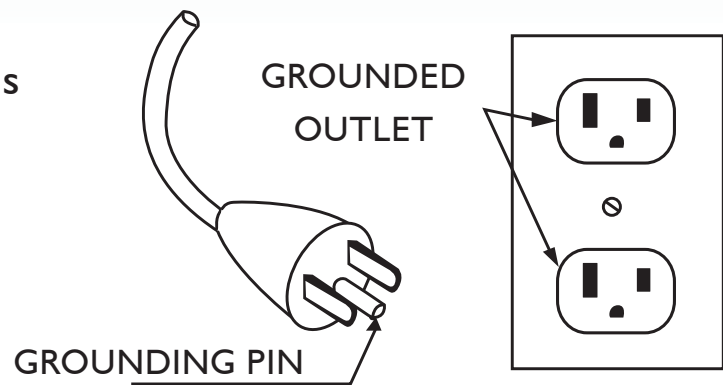

Note : Illustration is for Example purposes only. Your plug and required outlet may look different. **DO NOT MODIFY** plug that comes with PE10.

DISPLAY INSTRUCTION

The display of your PE10 is used to operate the unit. It includes information window and button area.



INFORMATION WINDOW



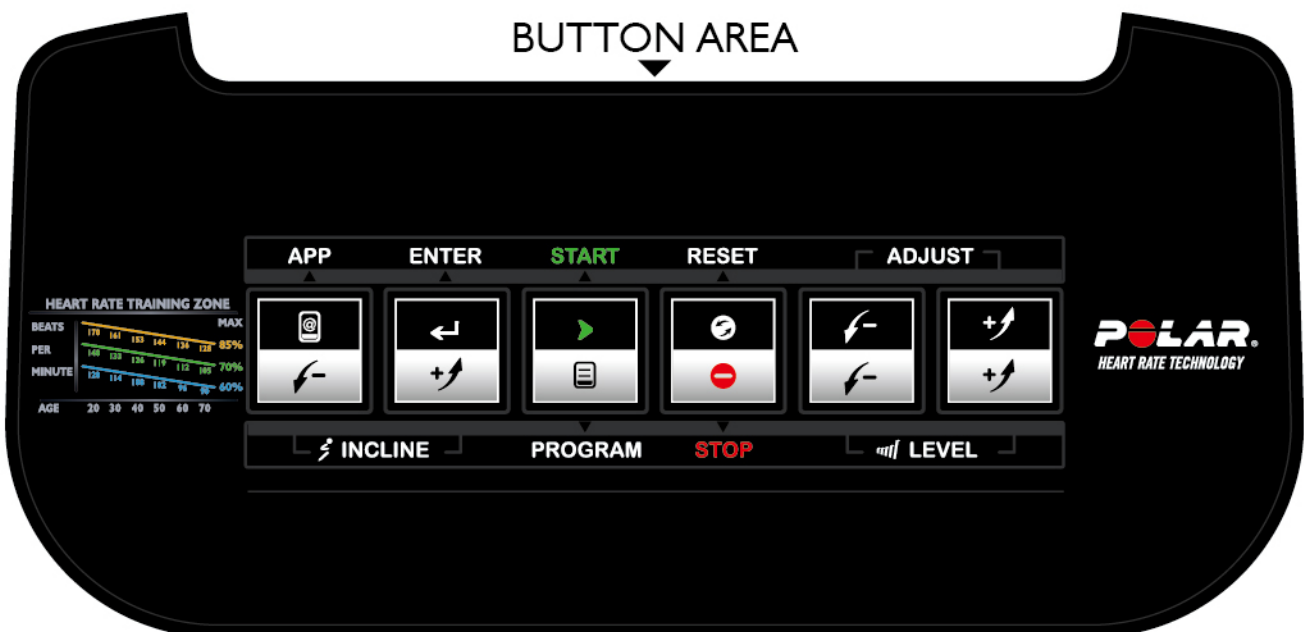





BUTTON AREA



INFORMATION WINDOW

Information window

The information window provides two different types of information: programs direction and user workout data. Programs directions will be explained with programs later. User workout data includes:





User workout data	Description
TIME 	Indicate time in minutes and seconds (mm:ss).
DISTANCE 	Indicate exercising distance of your workout.
CALORIES 	Indicates accumulated calories burned during workout.
PULSE 	Indicates heart rate beats per minute during your workout. (Only displayed if you are using contact heart rate bar or chest belt.)
INCLINE 	Indicates current incline of your workout.
RPM 	Indicates pedal rotations : per minute.
SPEED 	Indicates current speed of your workout.
LEVEL 	Indicates current resistance of your workout.

BUTTON AREA





BUTTON AREA

Description of each button is listed below.

Buttons are needed before starting workout.

<p>START</p> 	<p>Start your workout.</p>
<p>ENTER</p> 	<p>Enter data.</p>
<p>RESET</p> 	<p>Before pressing START, press RESET to reset data. After pressing START, press and hold RESET for a while to choose new workout program.</p>
<p>ADJUST</p> 	<p>Increase or Decrease setting value.</p>
<p>APP</p> 	<p>Reset APP connect.(Bluetooth)</p>









Buttons are needed after starting workout.

<p>STOP</p> 	<p>During workout, press one time to pause your workout(time stops counting). Press second time to start your workout again(time keeps counting). Elevation motor stops when you press STOP during incline or decline.</p>
<p>PROGRAM</p> 	<p>If you choose one of CARDIO, FAT BRUN, INTERVAL or TRAINING program in the beginning, during your workout, you can press PROGRAM to switch to other three programs. (Can not be used under other programs.)</p>
<p>INCLINE</p> 	<p>Increase or decrease workout resistance.</p>
<p>LEVEL</p> 	<p>Program profile changes during workout.</p>

OPERATION INSTRUCTION

Engineer Mode

Steelflex products are designed for different users. Base on your location and user characteristics; please follow the instruction to set up the machine before starting using.





step 1	Under selecting exercise program window, press and hold  and  together for a while, software version will be shown, then press  .
step 2	Press  or  to set metric/imperial, then press  .
step 3	“TOTAL TIME” which means accumulated total workout time will be shown, then press  .
step 4	AD(INCLINE TEST) setting. Press  to leave engineer mode.

OPERATION INSTRUCTION

Program

There are 10 different exercise programs which include manual, cardio, fat burn, interval, training, custom, goal-time, goal-distance, goal-calories and HRC. Operations are explained as following.

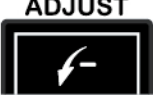
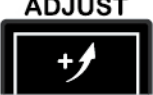
MANUAL











step 1	Set weight by pressing  or  , then press  .
step 2	Choose MANUAL by pressing  or  , then press  .

Note:

During workout, user can adjust resistance level and incline level.

OPERATION INSTRUCTION

CARDIO/FAT BURN/INTERVAL/TRAINING

step 1	Set weight by pressing  or  , then press  .
step 2	Press  or  to choose CARDIO/FAT BURN/INTERVAL/TRAINING , then press  .
step 3	Press  or  to set time, then press  .
step 4	Press  to start your workout.









Note:

During workout, you can press PROGRAM to switch to **CARDIO**, **FAT BRUN**, **INTERVAL** or **TRAINING** program.

During workout, you can adjust workout level which resistance level and incline level will be changed together.

OPERATION INSTRUCTION

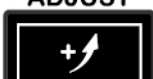

CUSTOM

step 1	Set weight by pressing  or  , then press  .
step 2	Press  or  to choose CUSTOM, then press  .
step 3	Press  or  to set each segment's resistance level. Press  to set next segment.
step 4	Press  to save your settings and start your workout.

During workout, you can adjust workout level which resistance level and incline level will be changed together.

OPERATION INSTRUCTION

GOAL-TIME

step 1	Set weight by pressing  or  , then press  .
step 2	Press  or  to choose GOAL-TIME, then press  .
step 3	Press  or  to set time, then press  .
step 4	Press  to start your workout.

During workout, you can adjust incline level and resistance level.

OPERATION INSTRUCTION









GOAL-DISTANCE

step 1	Set weight by pressing  or  , then press  .
step 2	Press  or  to choose GOAL-DISTANCE, then press  .
step 3	Press  or  to set distance, then press  .
step 4	Press  to start your workout.

During workout, you can adjust incline level and resistance level.

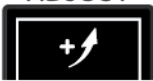
OPERATION INSTRUCTION

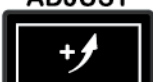











GOAL-CALORIES

step 1	Set weight by pressing  or  , then press  .
step 2	Press  or  to choose GOAL-CALORIES, then press  .
step 3	Press  or  to set calories, then press  .
step 4	Press  to start your workout.

During workout, you can adjust incline level and resistance level.

OPERATION INSTRUCTION

H.R.C.

step 1	Set weight by pressing  or  , then press  .
step 2	Press  or  to choose H.R.C., then press  .
step 3	Press  or  to set age, then press  . Default value is 30.
step 4	Press  or  to set target pulse %, then press  . Default value is 70%.
step 5	Press  to start your workout.

1. If heart rate is more than 20bpm below target, level will increase 2 every 30 seconds.
2. If heart rate is more than 10bpm below target, level will increase 1 every 30 seconds.
3. If heart rate is more than 20bpm above target, level will decrease 2 every 30 seconds.
4. If heart rate is more than 10bpm above target, level will decrease 1 every 30 seconds.
5. If heart rate can not be detected, PULSE will be showed on the display every 0.5 second, and level doesn't change.
6. During workout, you can adjust workout level which resistance level and incline level will be changed together.

OPERATION INSTRUCTION

APP CONNECTION

1. Under setting weight or selecting program, press  .
2. Turn on Bluetooth of your cell phone and connects APP with the machine.

3. You can set your workout data from APP, then press  from machine's console.

4. During connecting, press  to disconnect.

5. Programs of APP v.s. programs of console :

APP	CONSOLE
Program 1	MANUAL
Program 2	CARDIO
Program 3	FAT BURN
Program 4	INTERVAL
Program 5	TRAINING
Program 6	CUSTOM
Program 7	H.R.C.

MAINTENANCE

All STEELFLEX series products are designed for heavy usage environment. To keep your product in good condition, STEELFLEX strongly recommends the following maintenance routines below.

FOR ALL UPRIGHT AND RECUMBENT BIKES

Item	Prior to use	Weekly	Monthly	Quarterly	Bi-Annual
Console		Clean			
Handlebar connection				Inspect Tighten as required	
Outer covers		Clean			
Foot straps	Inspect				
Seat Fasteners			Inspect Tighten as required		
Seat Post					Apply light coat of lubricant
Crank arms			Inspect Tighten as required		

FOR ALL ELLIPTICAL AND STEPPER

Item	After Use	Weekly	Monthly	Quarterly	Bi-Annual
Console	Clean				Inspect
Console Mounting Bolts					Inspect and tighten
Outer covers		Clean			
Fasteners			Inspect and tighten		
Bearings				Inspect and tighten	
Footpads			Inspect and tighten		

WARRANTY CONDITIONS

WARRANTY CONDITIONS

1. Ask your dealer about product warranty conditions.
2. The warranty applies only to the original owner, and covers the cost of parts repair or replacement and does not include freight charges. Proof of purchase must be demonstrated.
3. The warranty applies only to the original owner and is non transferable. If you are in US., the warranty card must be completed and sent back to FMI to complete registration. If you are out of US., please contact your dealer about your warranty situation.
4. Labor coverage is provided only by authorized STEELFLEX dealer or if the STEELFLEX factory does the work.
5. Any reimbursement for travel outside of the dealers' normal service or coverage area will be the responsibility of the customer.
6. Warranty does not cover failure due to improper assembly, installation or use.

WARRANTY CONDITIONS

7. This warranty does not cover customer instruction, installation, set up or adjustment. User is responsible for necessary maintenance.

8. The warranty will not be extended to any product whose serial number has been removed, altered, or defaced.

9. This warranty does not cover damage or equipment failure caused by, or resulting from accident, misuse, abuse, improper assembly or installation, un-authorized modification, or failure to provide reasonable and necessary care as outlined in the owner's manual.

CARDIO
CARDIO

Steelflex
USER MANUAL

USER MANUAL V.6